

Mass Timber: Knowing Your Options

Presentation to the Architectural Institute of BC
& the American Institute of Architects

24 October, 2013

Ian Boyle

P.Eng., Struct.Eng., P.E., S.E.

Bernhard Gafner

P.Eng., MIStructE, C.Eng., Dipl.Ing. FH/STV

Fresh Thinking | Holistic Design



Outline |

- Overview
- Design process + case studies
- Future
- Useful tools



Overview |

- Definition of Mass Timber
- Structural Building Systems
- Products
- Sizes and Design Characteristics
- Comparison

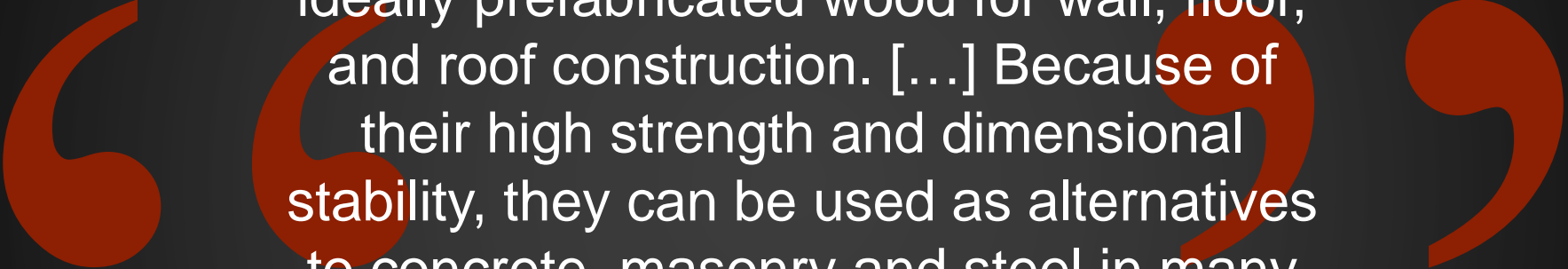

Mass timber construction uses large and ideally prefabricated wood for wall, floor, and roof construction. [...] Because of their high strength and dimensional stability, they can be used as alternatives to concrete, masonry and steel in many building types.

❖ Quote from MassTimber.com

Overview | **Building Systems**

Building Systems |

Light Wood Frame (Stick Frame)

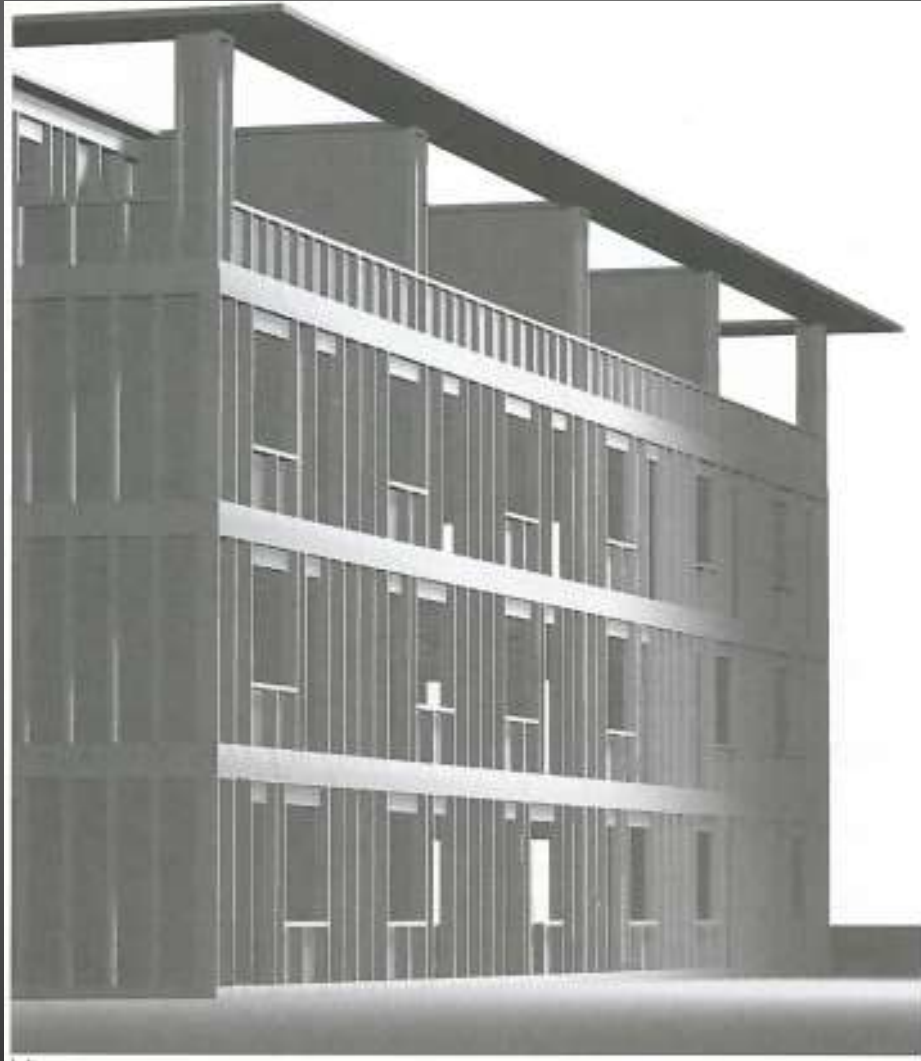

Building Systems |

Post + Beam (with Mass Timber or light wood frame floors)



Building Systems |

Mass Timber (100%)

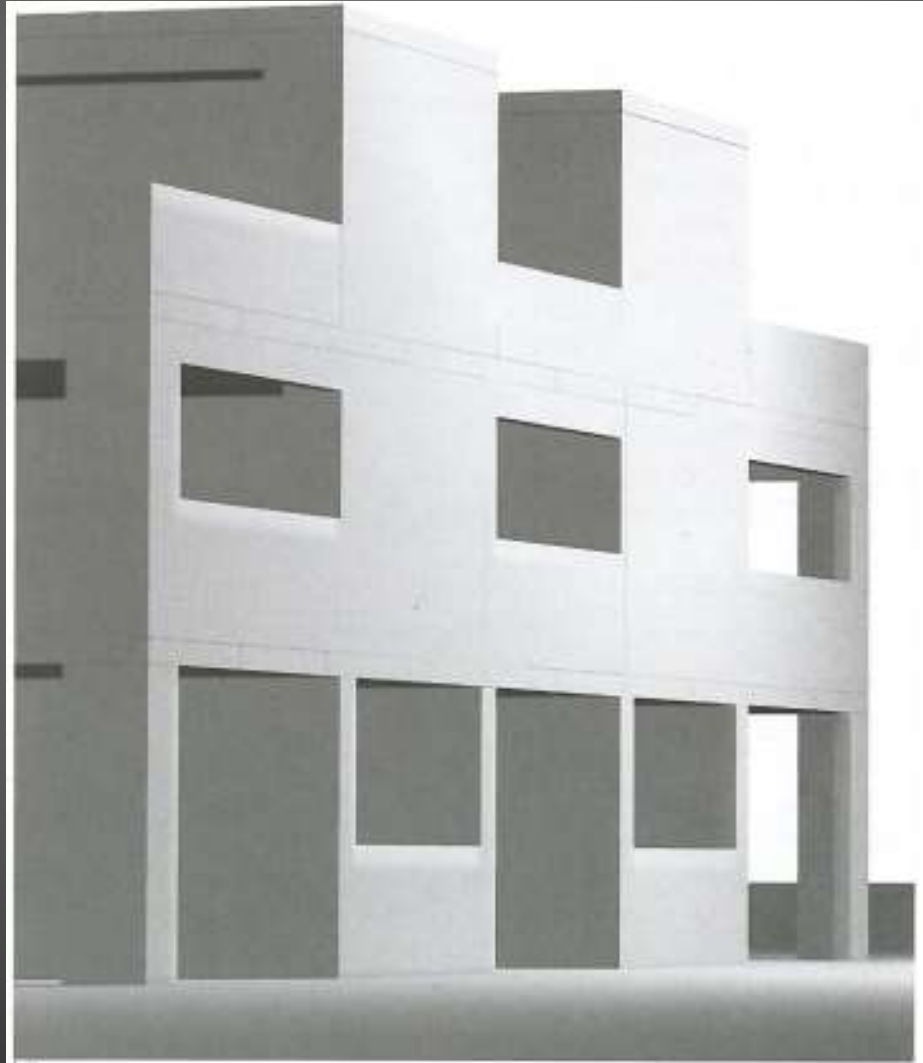

Building Systems |

Light Wood Frame



Institutional

Post + Beam



Mass Timber Floors
(and Shearwalls)

Residential

Mass Timber (100%)



Mass Timber Walls and
Floors

Building Systems |

Light Wood Frame



Institutional

Post + Beam



Residential

Mass Timber (100%)

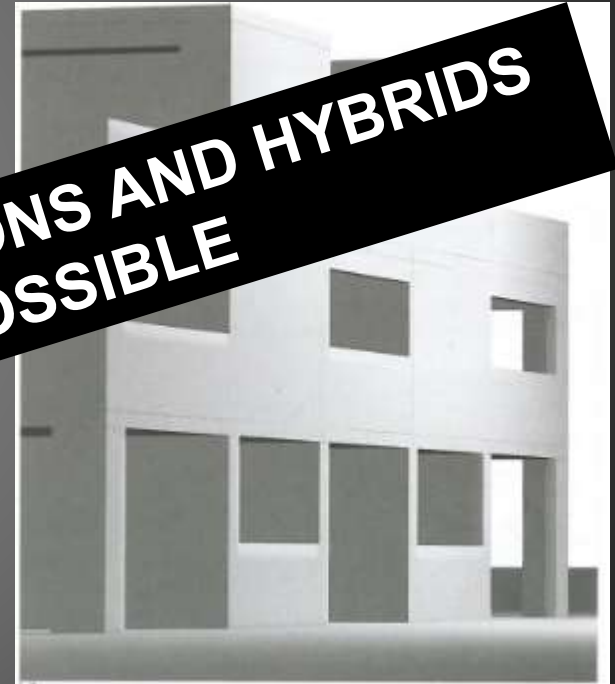

**LOTS OF VARIATIONS AND HYBRIDS
ARE POSSIBLE**

Mass Timber Floors
(and Shearwalls)

Mass Timber Walls and
Floors

Overview | **Products**

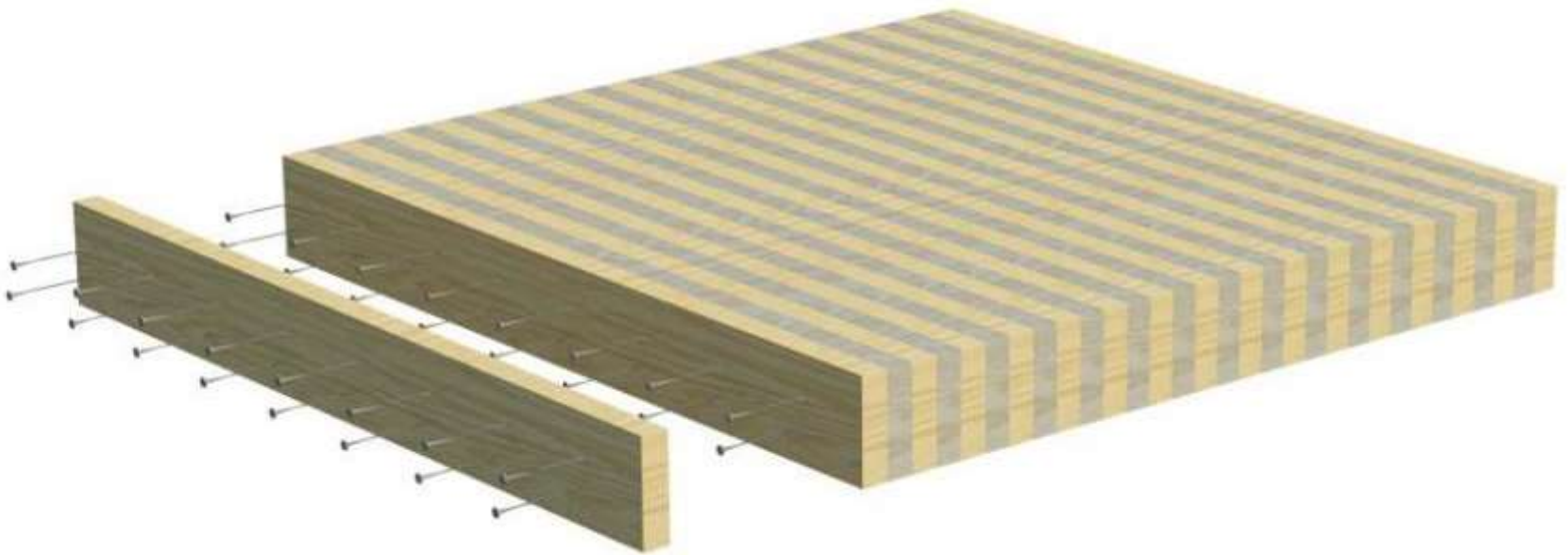

Nail Laminated Timber

Alternative

Names: nailed timber, nail-up, edge-lam, brettstapel

System: regular framing members (2x, 3x) on edge + fastened together

Suppliers: a good carpenter

Basic Info:

- material/fibre used: S-P-F / Douglas Fir or any other
- harvesting cycle: 80 years
- floor, roof (and wall) with Plywood sheathing for lateral loads

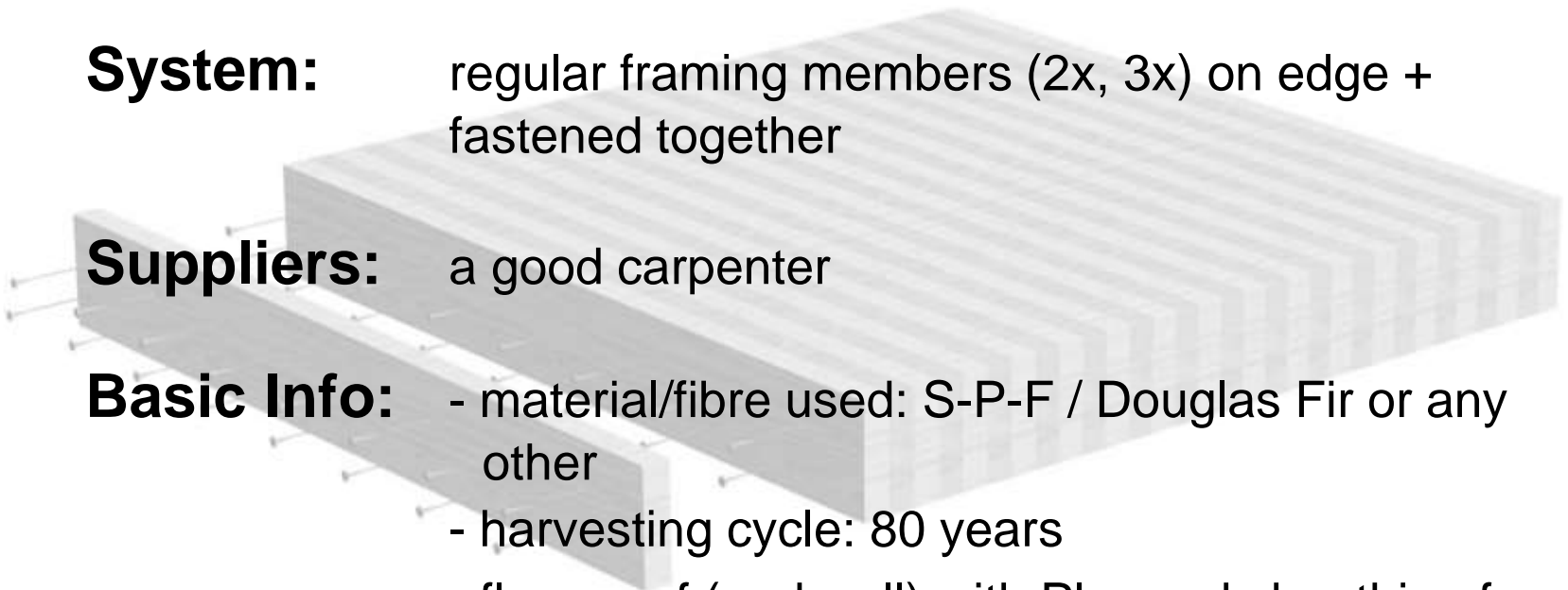

Comments:

- Non-standardized panel product

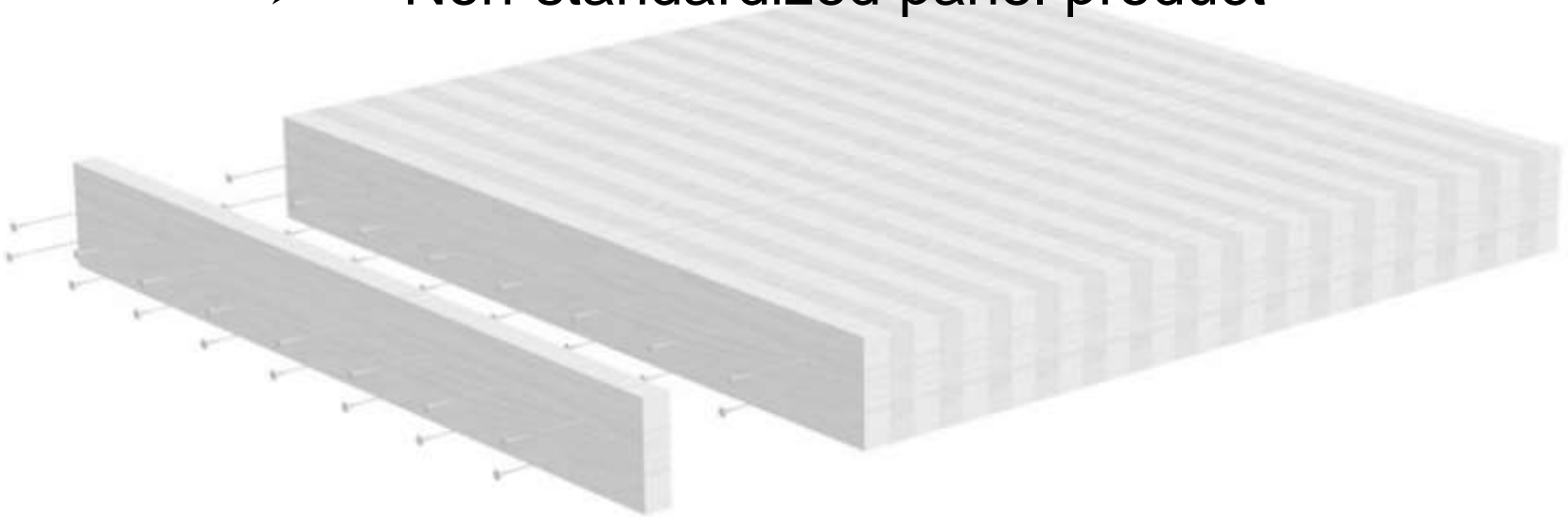

Comments:

- Non-standardized panel product

- base material covered with grading rules





Courtesy of Nicola Log Works

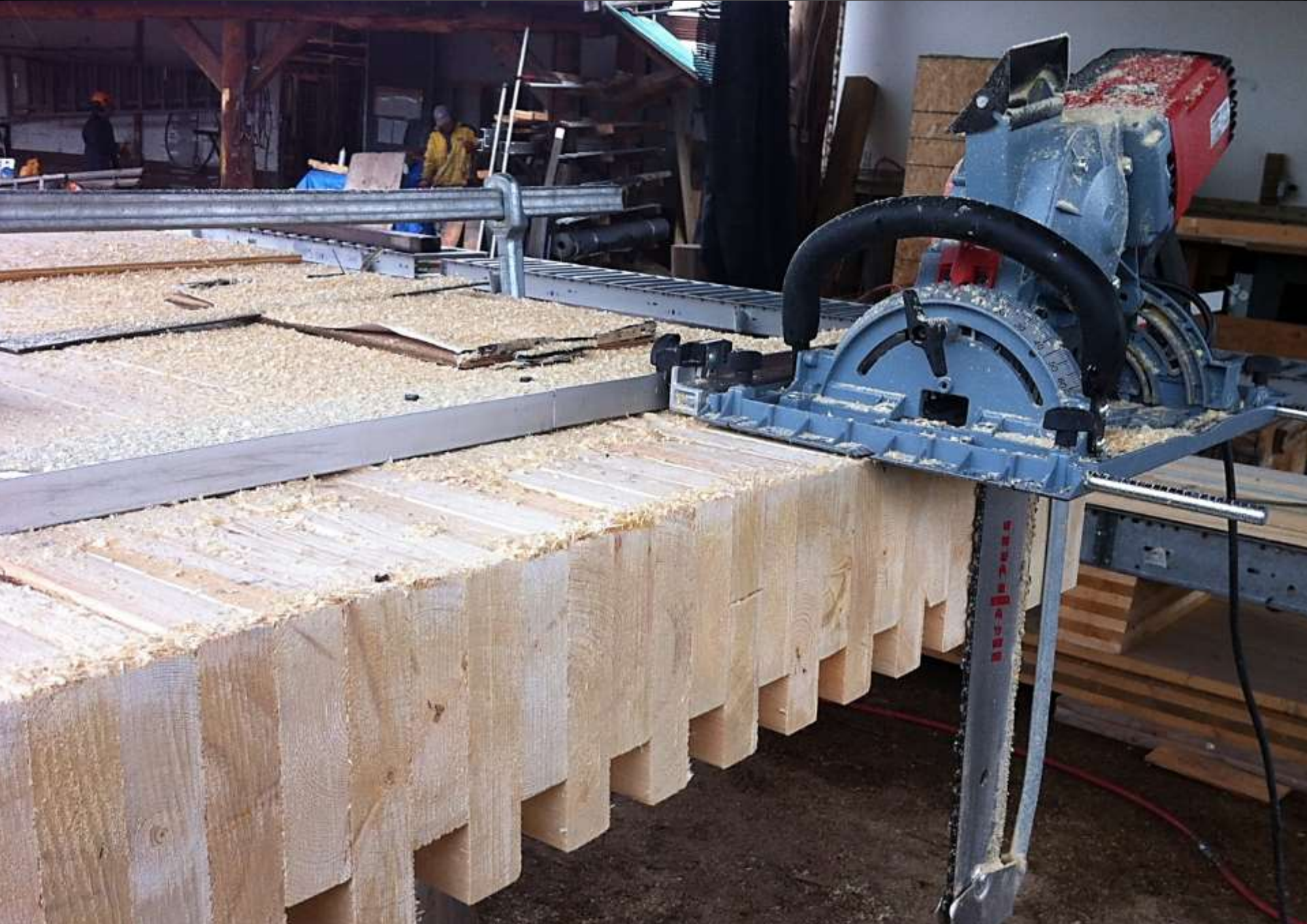

Courtesy of Nicola Log Works

Comments:

- Non-standardized panel product
- Specifications

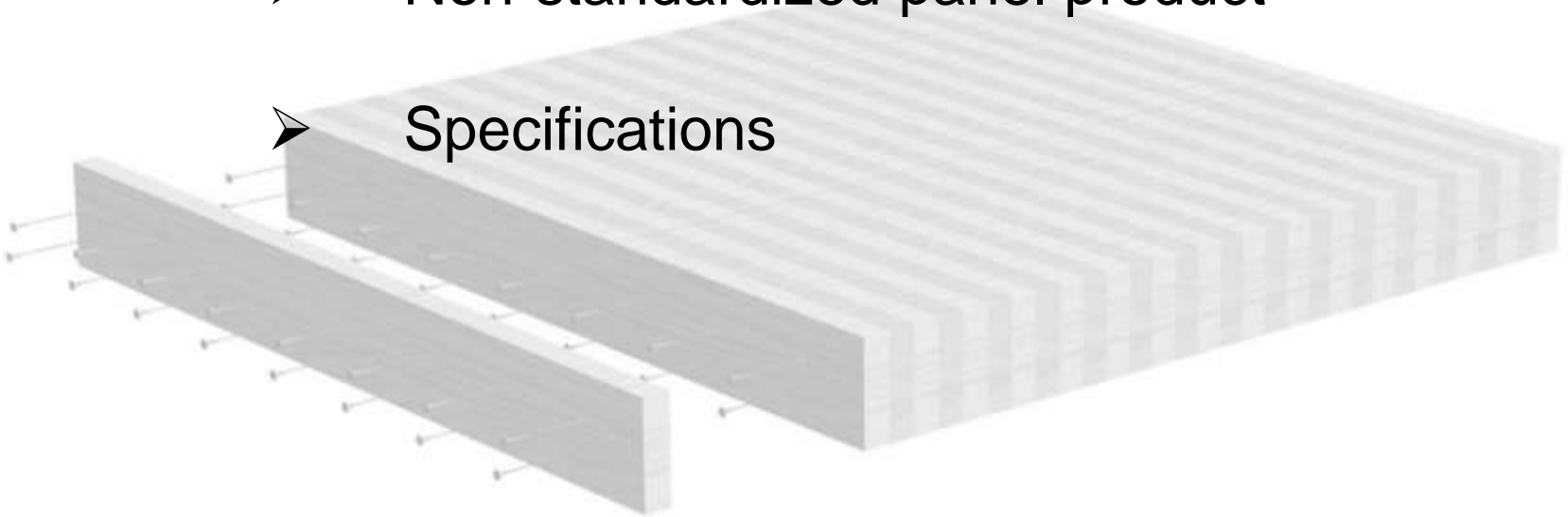



Comments:

- Non-standardized panel product
- Specifications
- Requires care with regards to swelling / shrinkage perpendicular to grain

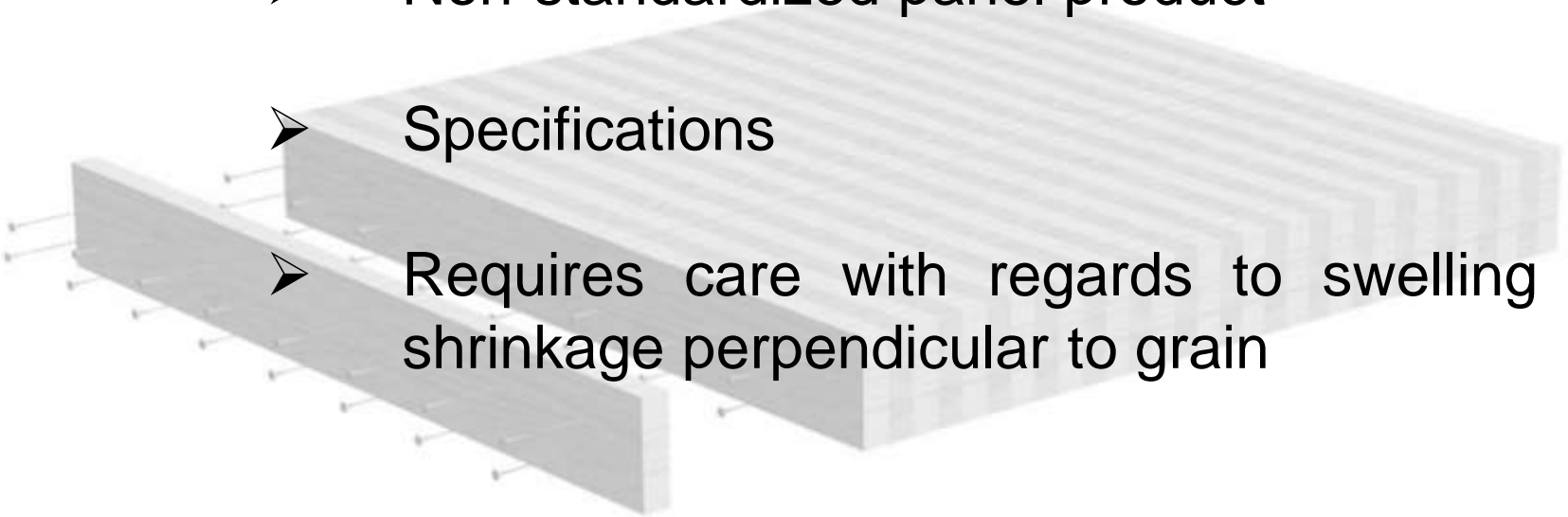

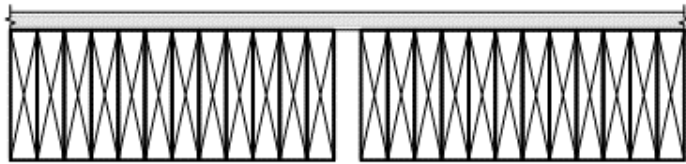

38 OR 76
(1 OR 2 LAMINATION)
GAP TO BE FILLED IN AFTER
BUILDING IS ENCLOSED.
GLUE OR PIN NAIL.

2 SHRINKAGE / SWELLING GAP
TYP. GRIDS B, C, F AND G ONLY



NLT | **Samuel Brighthouse Elementary**











Overview | **Products**

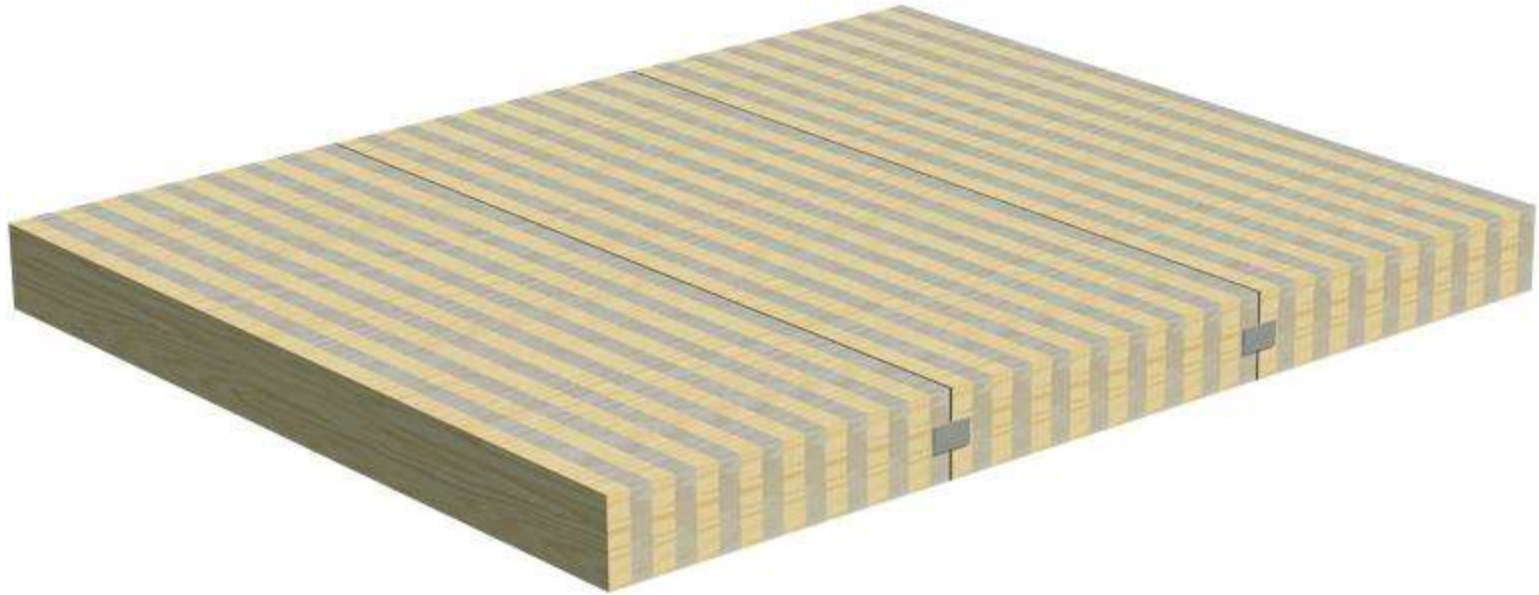

Glue Laminated Timber

Alternative

Names: glued edge laminated timber,
edge laminated timber, edge-lam

System: “glulam beams on edge”

Suppliers: Structurlam (Penticton), Western Archrib
(Edmonton), Nordic (Montreal) or any other glulam
supplier

Basic Info:

- material/fibre: S-P-F / D. Fir / Black Spruce / ...
- harvesting cycle: 80 years
- adhesive: Phenol Resorcinol (black) or
Melamine (clear)
- adhesive amount: 1% by weight
- floor, roof (and wall) with Plywood sheathing for
lateral loads

Comments:

- Standardized product

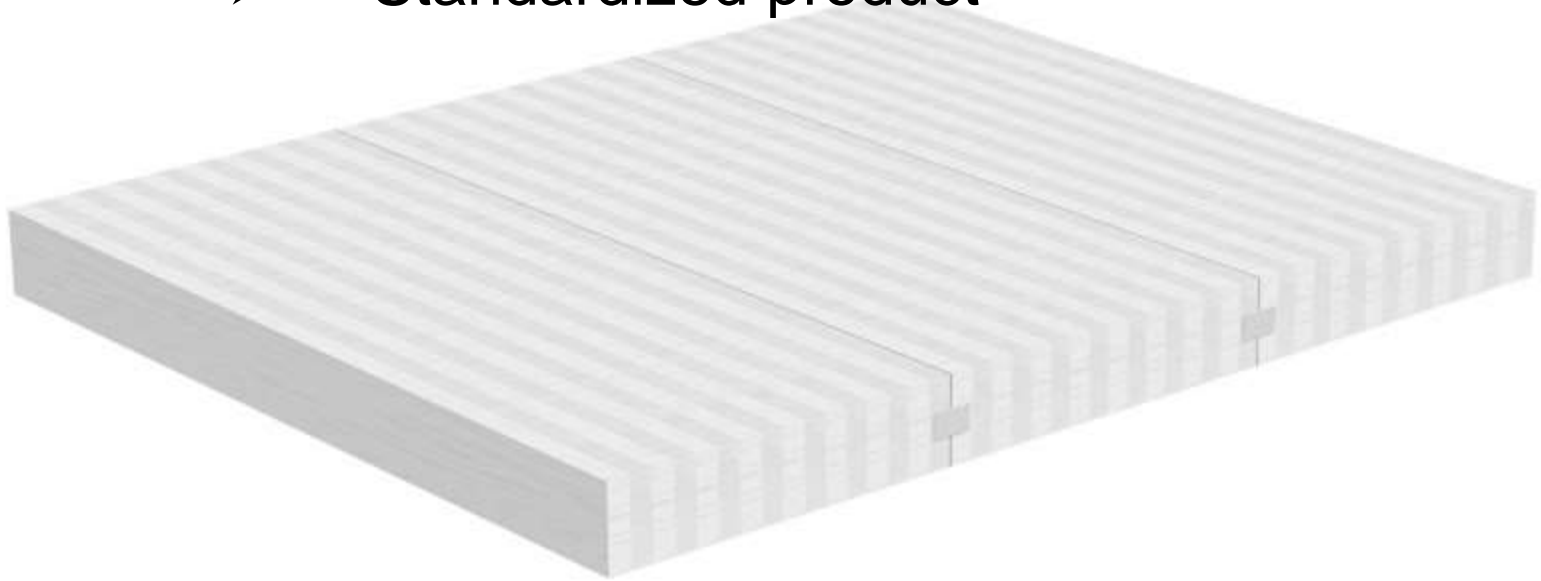

GLT |



Comments:

- Standardized product
- Requires care with regards to swelling / shrinkage perpendicular to grain

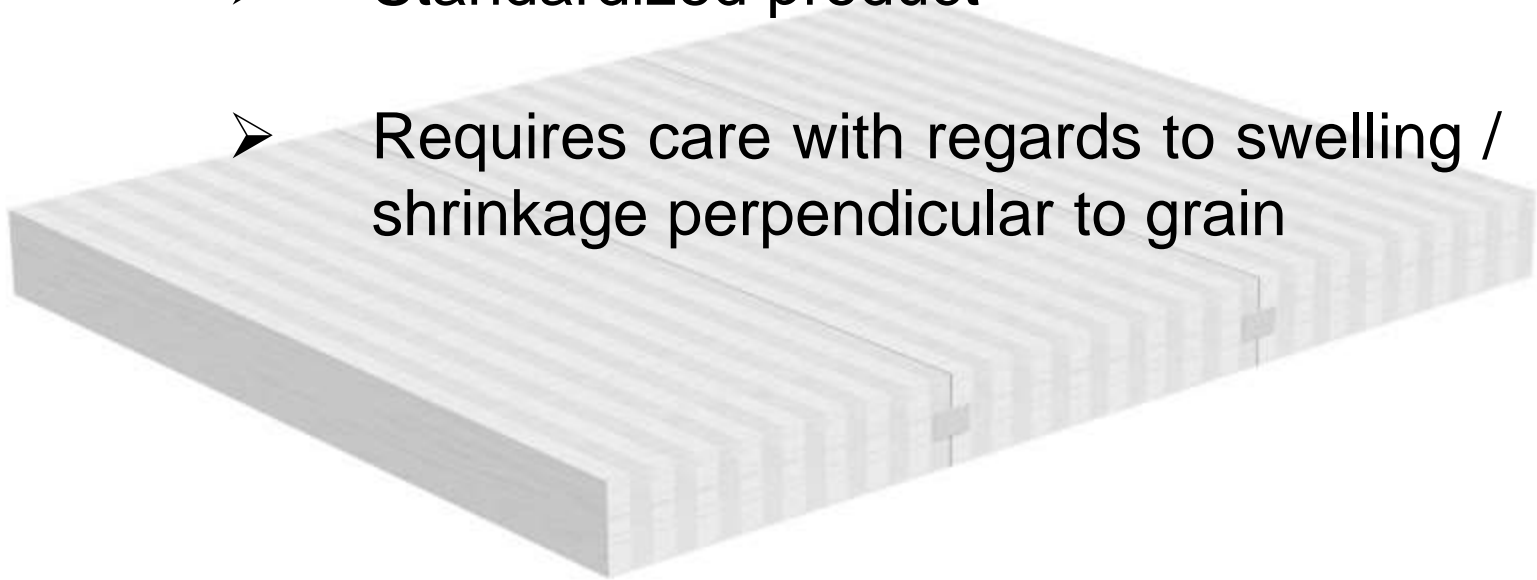

GLT |

D.FIR PLY OVER GLT PANELS
AS PER PLAN, U.N.O.
GLUE PLY TO GLT PANELS &
FASTEN WITH 76mm COMMON
NAILS @ 75mm AT ALL PLY
PANEL EDGES.

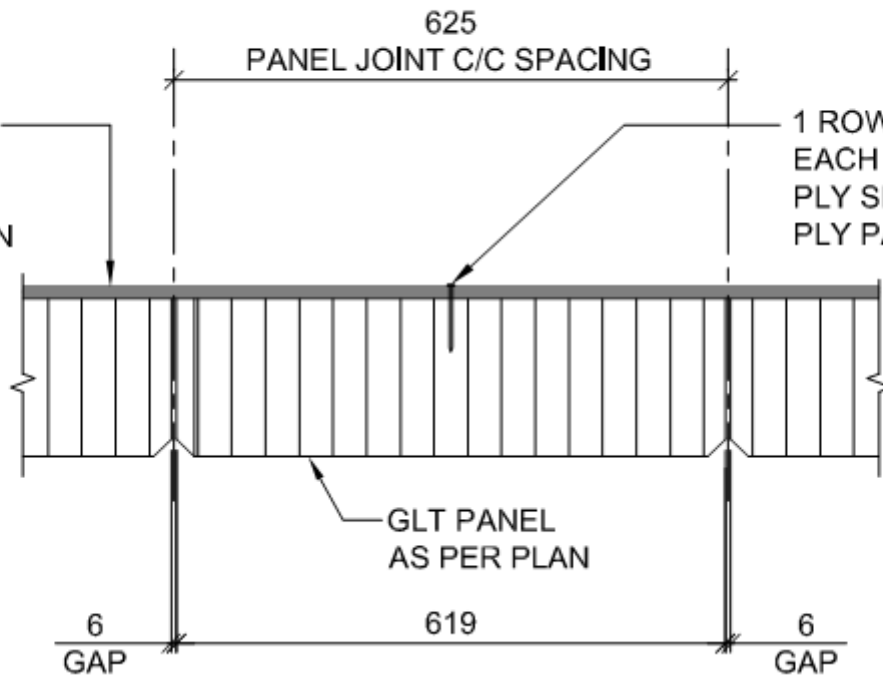

Comments:

- Standardized product
- Requires care with regards to swelling / shrinkage perpendicular to grain
- Glulam beam \neq GLT

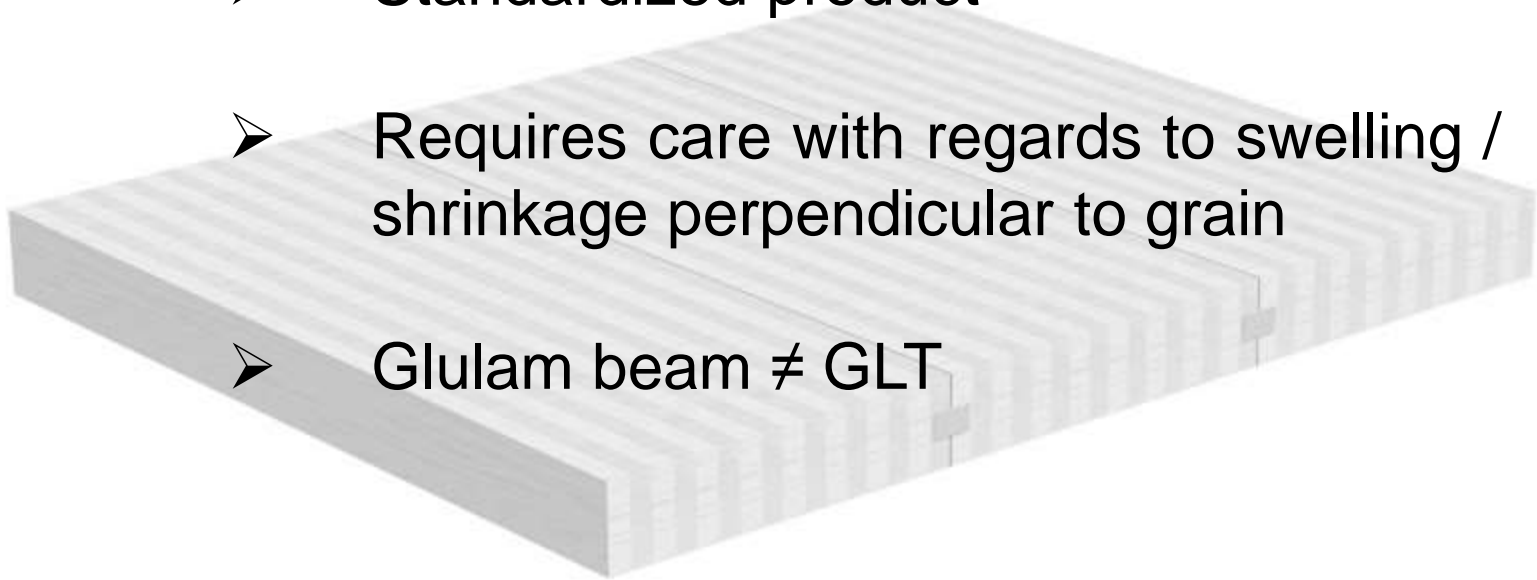

GLT |

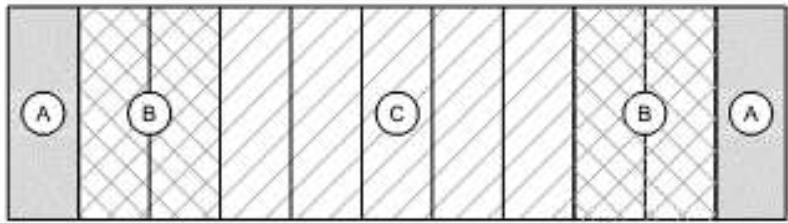
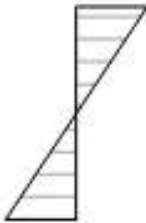
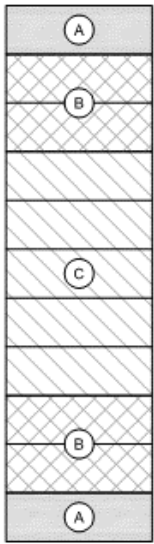
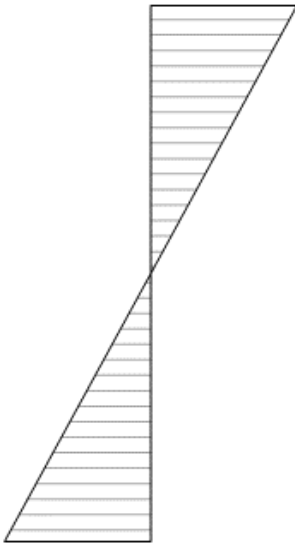

GLT |

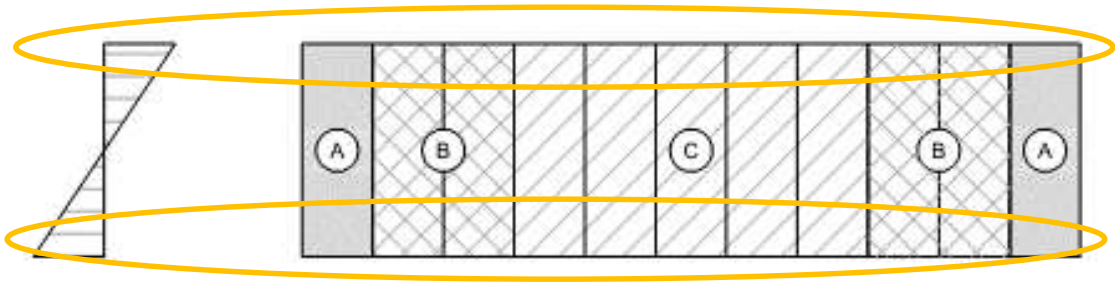
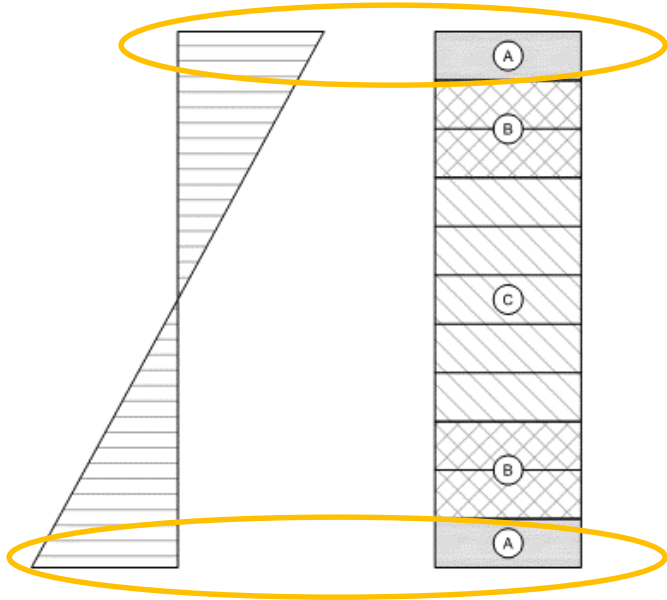





GLT | Kin Centre Arena Complex





Overview | **Products**

Overview | CLT

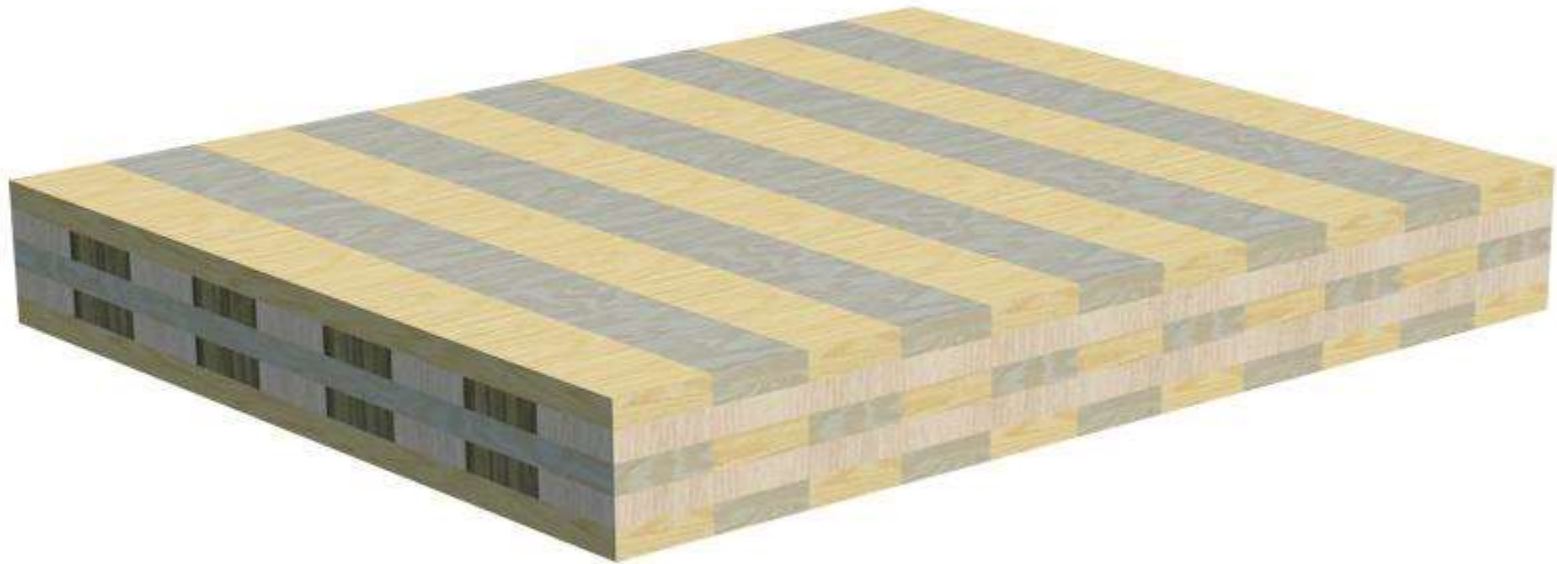

Cross Laminated Timber

Alternative

Names: cross laminated timber, x-lam

System: cross laminated timber panels → 2x members glued together

Suppliers: Structurlam (Penticton, BC), Nordic (Montreal, QC), Smartlam (Whitefish, MT)

Basic Info:

- material/fibre: S-P-F / Black Spruce
- harvesting cycle: 80 to 100 years
- adhesive: Polyurethane
- adhesive amount: 4% by weight
- floor, roof and wall with joints detailed for lateral loads

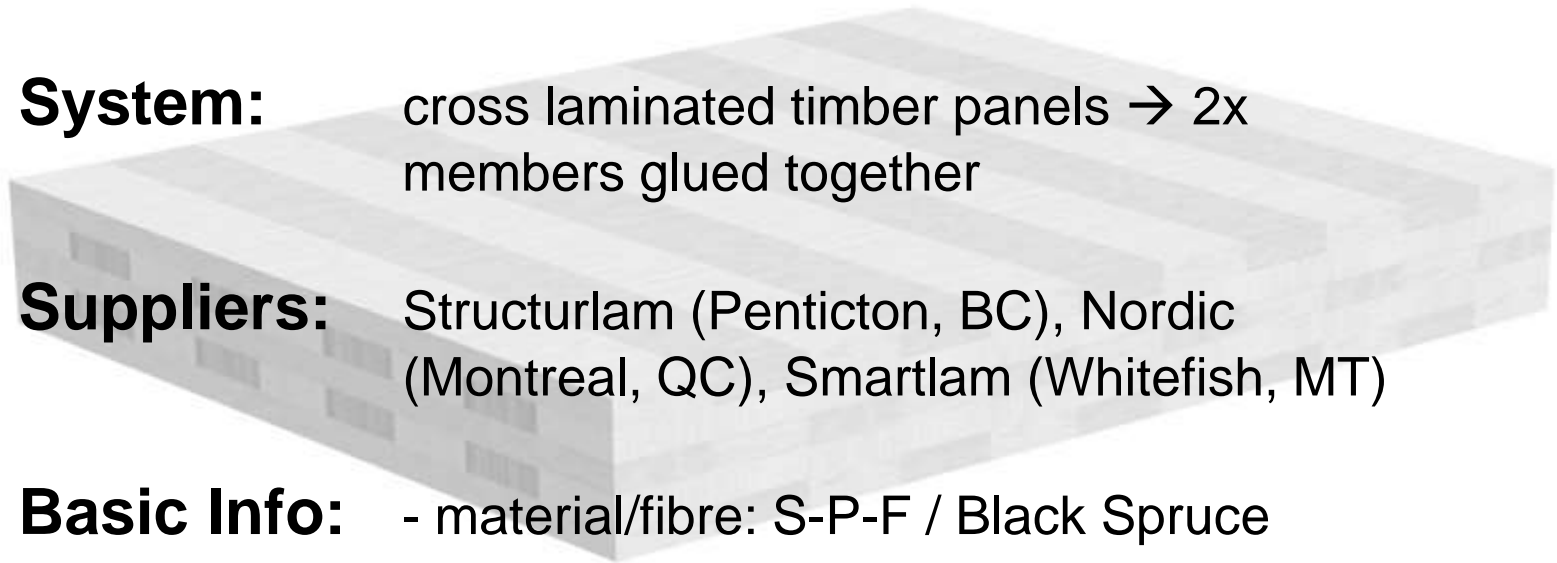

Comments:

- Standardized product

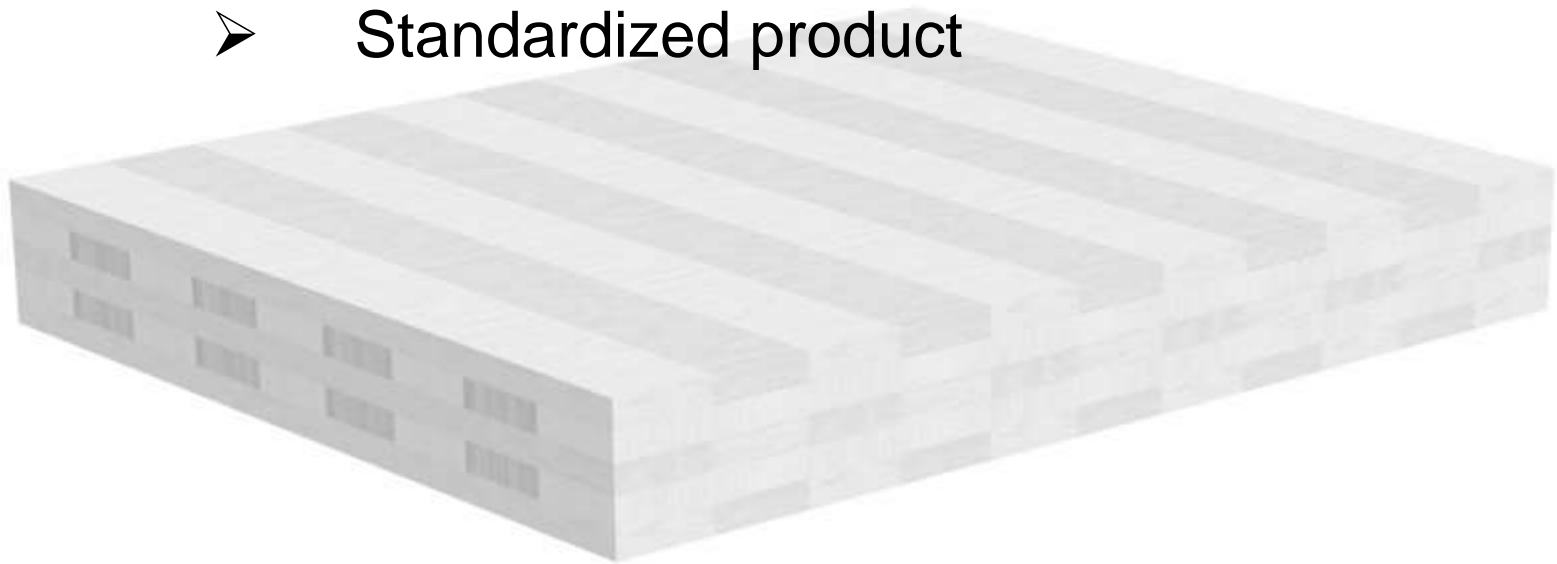

CLT |



Comments:

- Standardized product
- Dimensionally very stable



CLT |

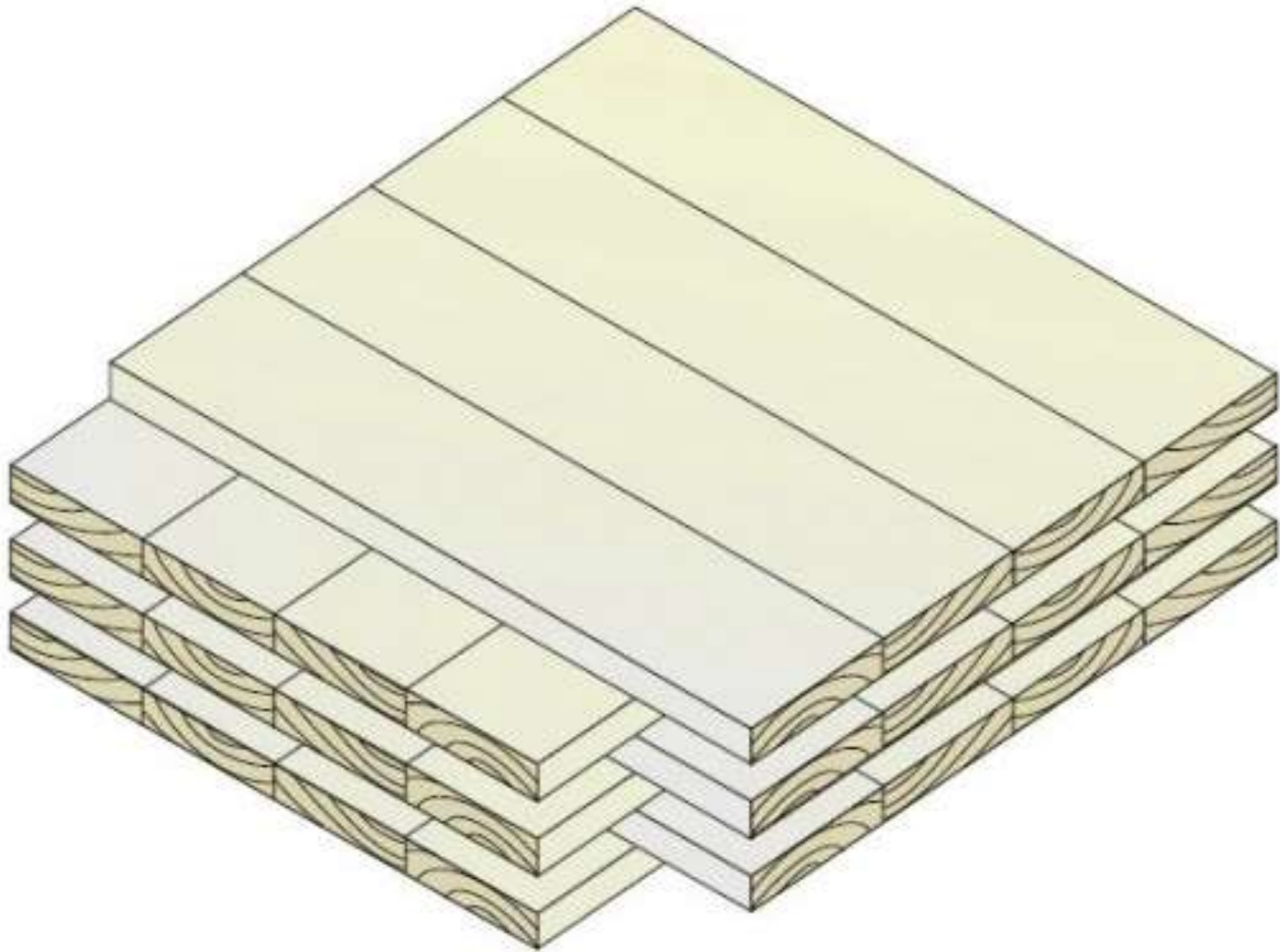

Comments:

- Standardized product
- Dimensionally very stable
- Two directional span capabilities

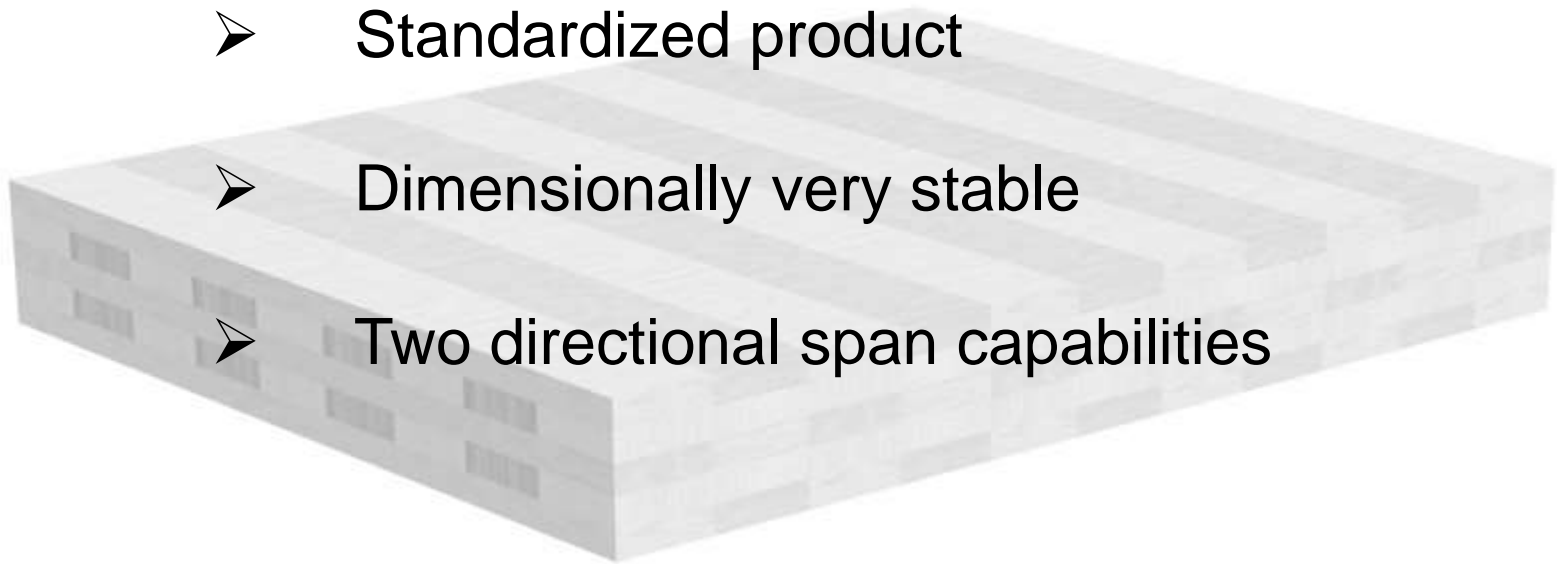

CLT |

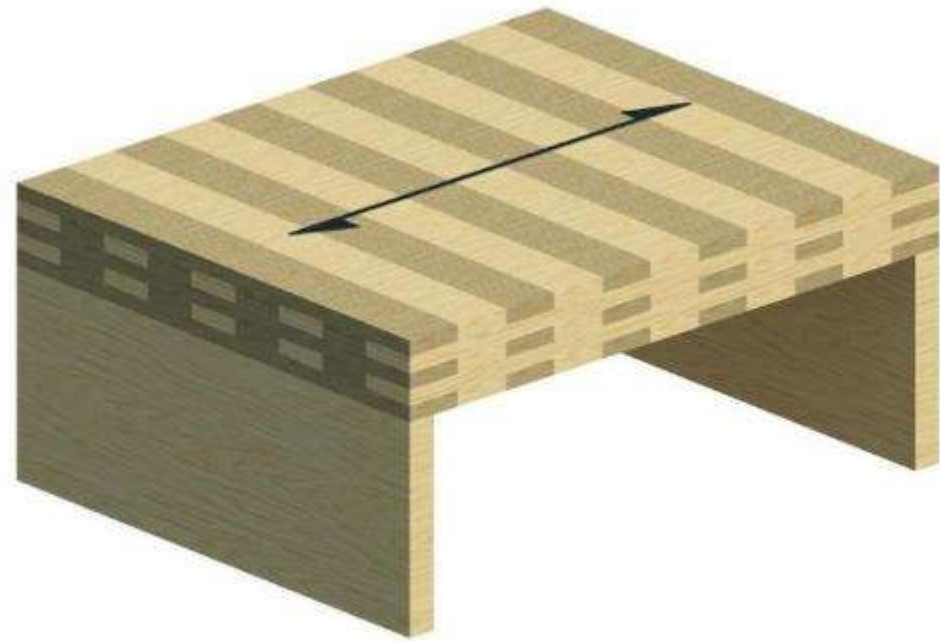
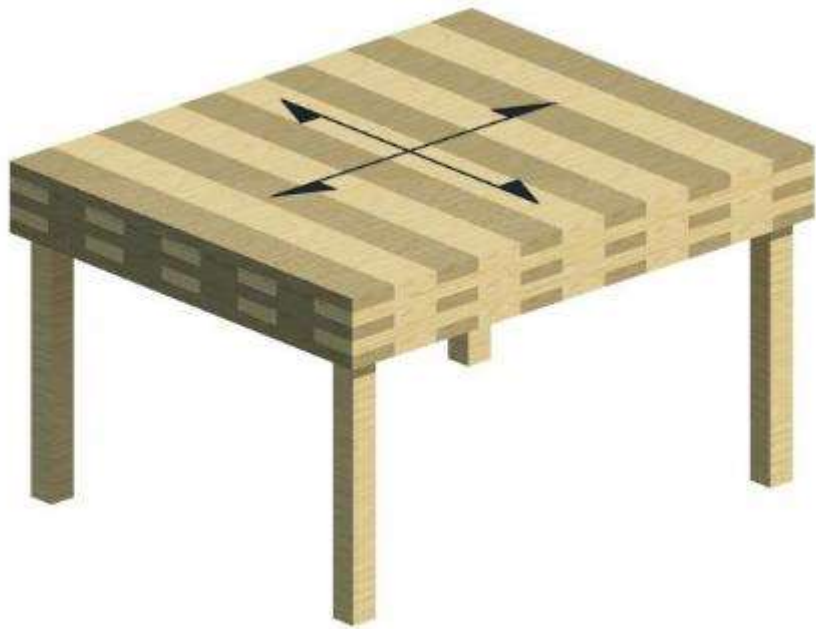

CLT | Wayne Gretzky Centre



Courtesy of Structurlam Products



Courtesy of Structurlam Products

CLT | **District 03**



Courtesy of Nordic



Courtesy of Nordic

Overview | **Products**

Overview | **Solid LSL**



Laminated Strand Lumber

Solid LSL |

Alternative

Names: n/a

System: laminated strand lumber (timber strands glued together)

Suppliers: *Weyerhaeuser, Louisiana Pacific,

Basic Info*:

- material/fibre: Aspen
- harvesting cycle: 60 to 70 years
- adhesive: MDI - Isocyanate
- adhesive amount: 6% by weight
- floor, roof and wall with joints detailed for lateral loads (limited thicknesses!)

Solid LSL |

Comments:

- Standardized product



Solid LSL |



Solid LSL |

Comments:

- Standardized product
- Dimensionally relatively stable

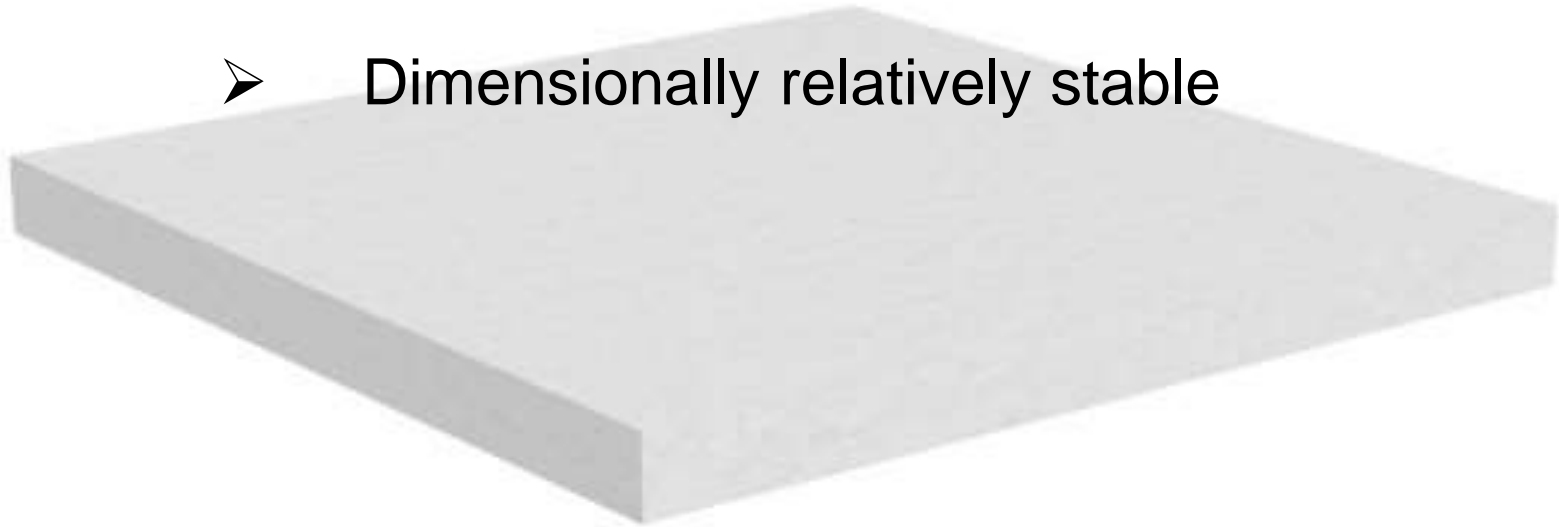

Solid LSL |



Solid LSL | Gilmore SkyTrain Station



Perkins + Will Canada



Solid LSL | False Creek Community Centre



Henriquez + Partners Architects

Overview | **Products**

Overview | **Solid LVL**



Laminated Veneer Lumber

Solid LVL |

Alternative

Names: Microlam, Versalam

System: laminated veneer lumber (veneers stacked & glued together)

Suppliers: Louisianan Pacific*, Weyerhaeuser, Boise Cascade, West Fraser, Metsawood

Basic Info*:

- material/fibre: D. Fir
- harvesting cycle: 80 years
- adhesive: Phenol Formaldehyde
- adhesive amount: 7% by weight
- floor, roof and wall with joints detailed for lateral loads (limited thicknesses!)

Solid LVL |

Comments:

- Standardized product

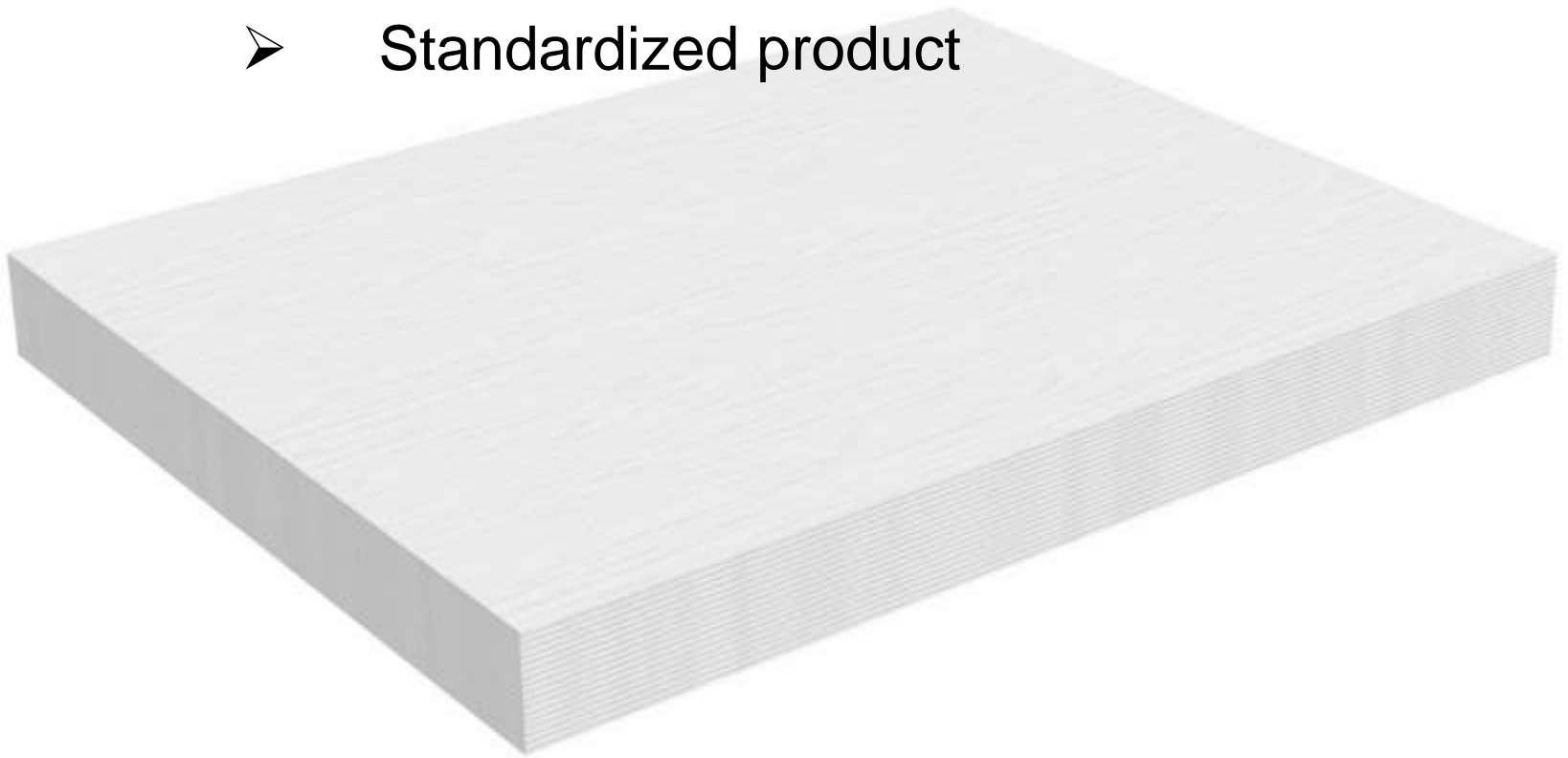

Solid LVL |



Solid LVL |

Comments:

- Standardized product
- Dimensionally relatively stable (can add cross layers)

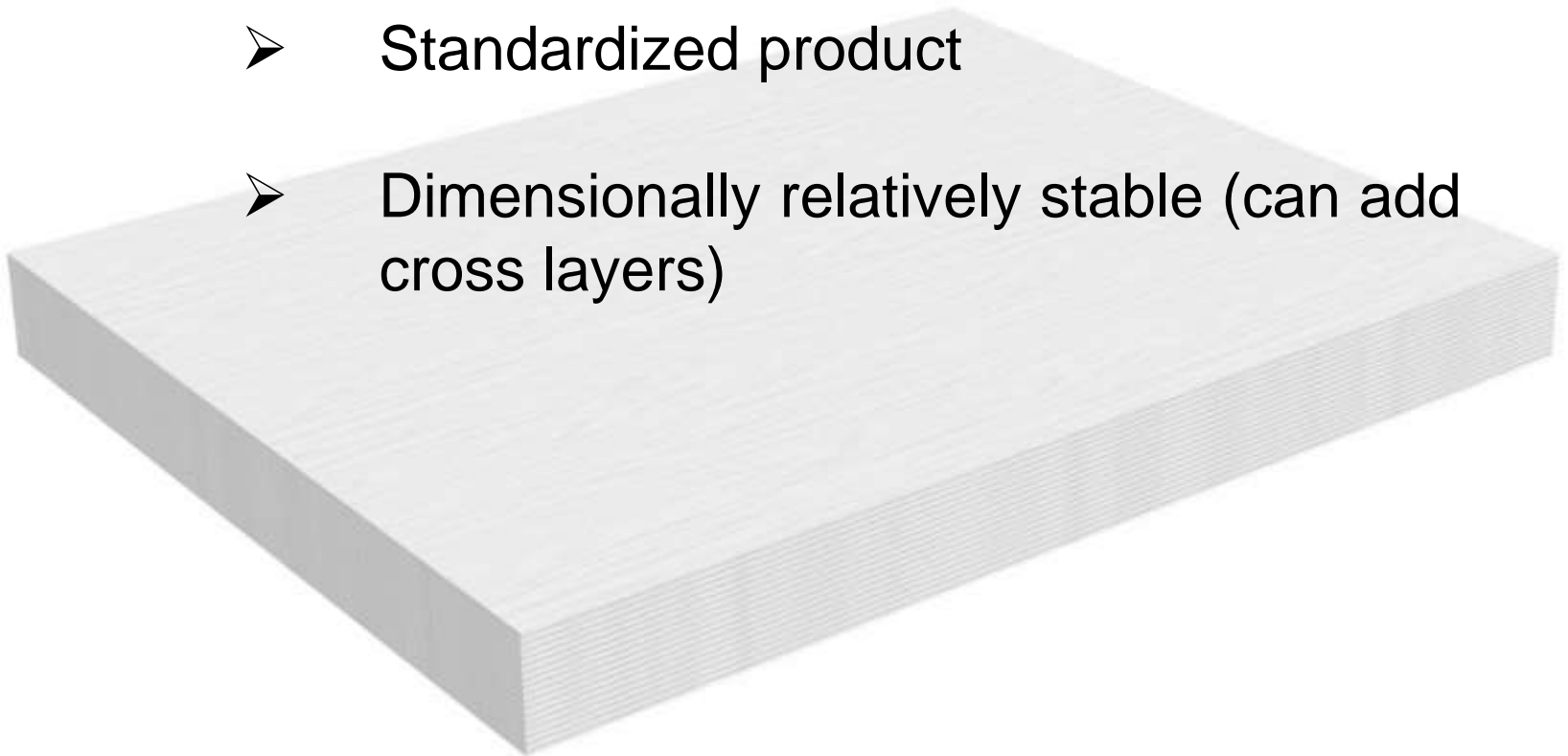

Solid LVL |



Solid LVL |



Solid LVL |



Overview | **Products**

Overview | **Brisco Fine Line LVL**

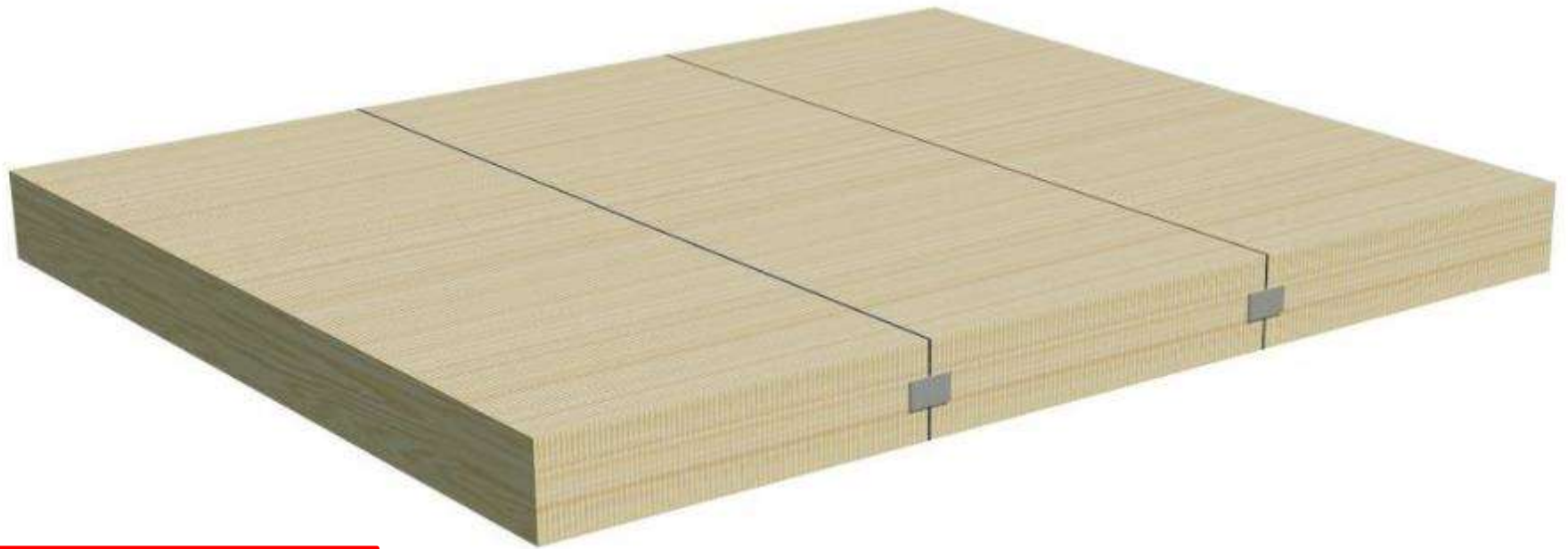

Laminated Veneer Lumber

Brisco Fine Line LVL |

Alternative

Names: N/A

System: laminated veneer lumber (veneers stacked & glued together)

Suppliers: Brisco

Basic Info:

- material/fibre: D. Fir
- harvesting cycle: 80 years
- adhesive: Phenol Formaldehyde
- adhesive amount: 7% by weight
- floor, roof and wall with joints detailed for lateral loads

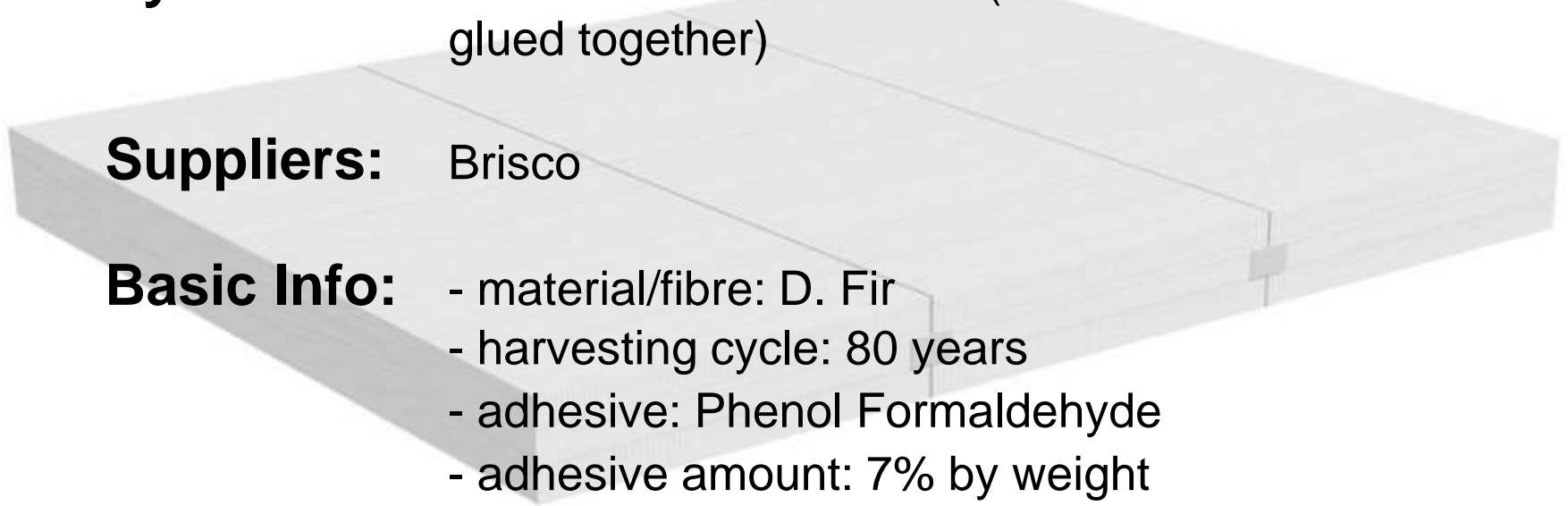

Brisco Fine Line LVL |

Comments:

- Standardized product

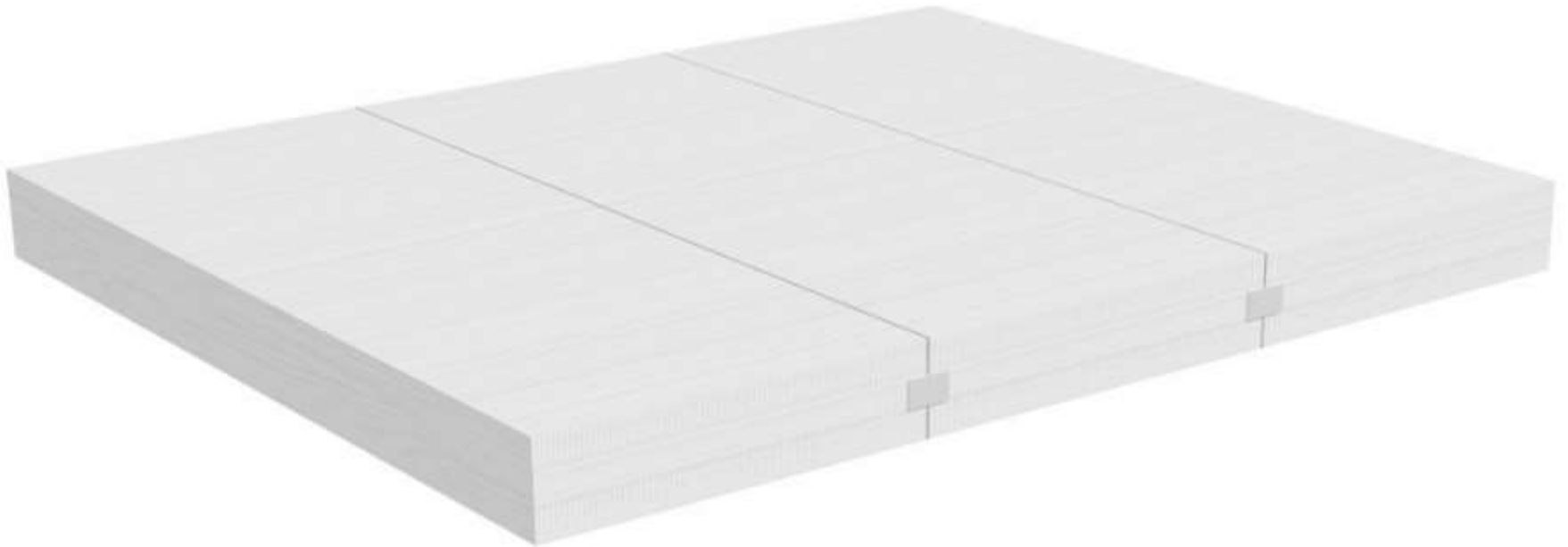

Brisco Fine Line LVL |



Brisco Fine Line LVL |

Comments:

- Standardized product
- Dimensionally relatively stable

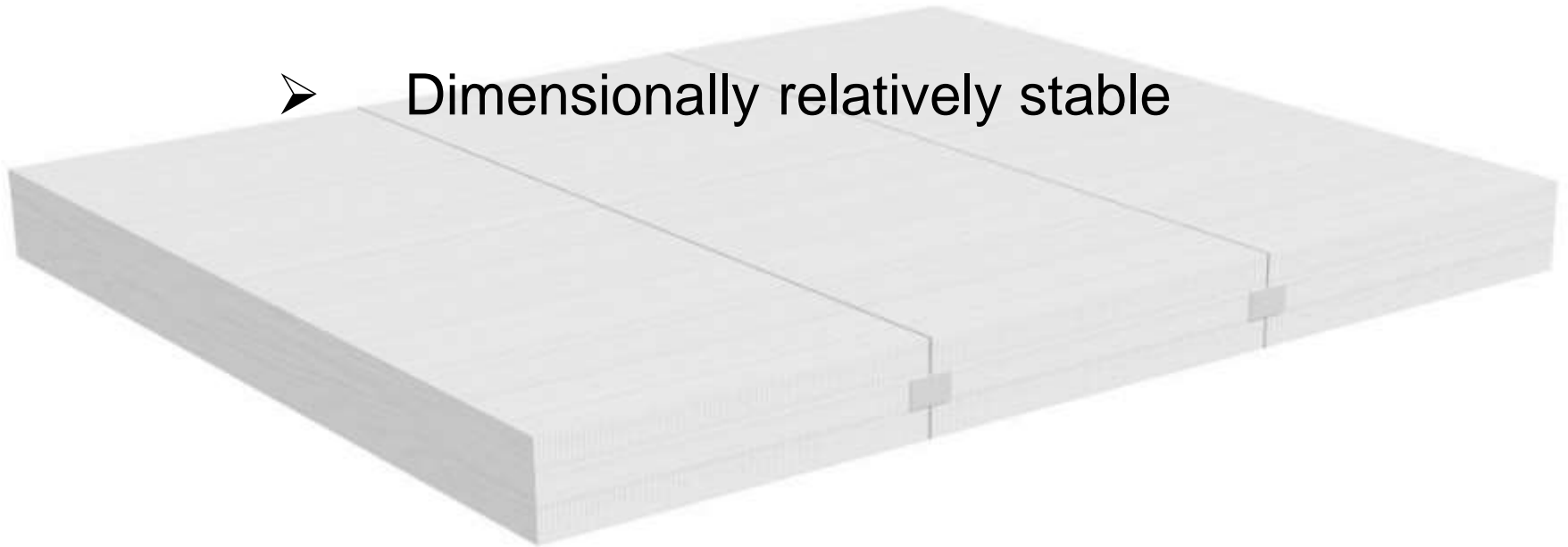

Brisco Fine Line LVL |



Courtesy of Brisco



Courtesy of Brisco



Courtesy of Brisco



Courtesy of Brisco

Overview | **Products**

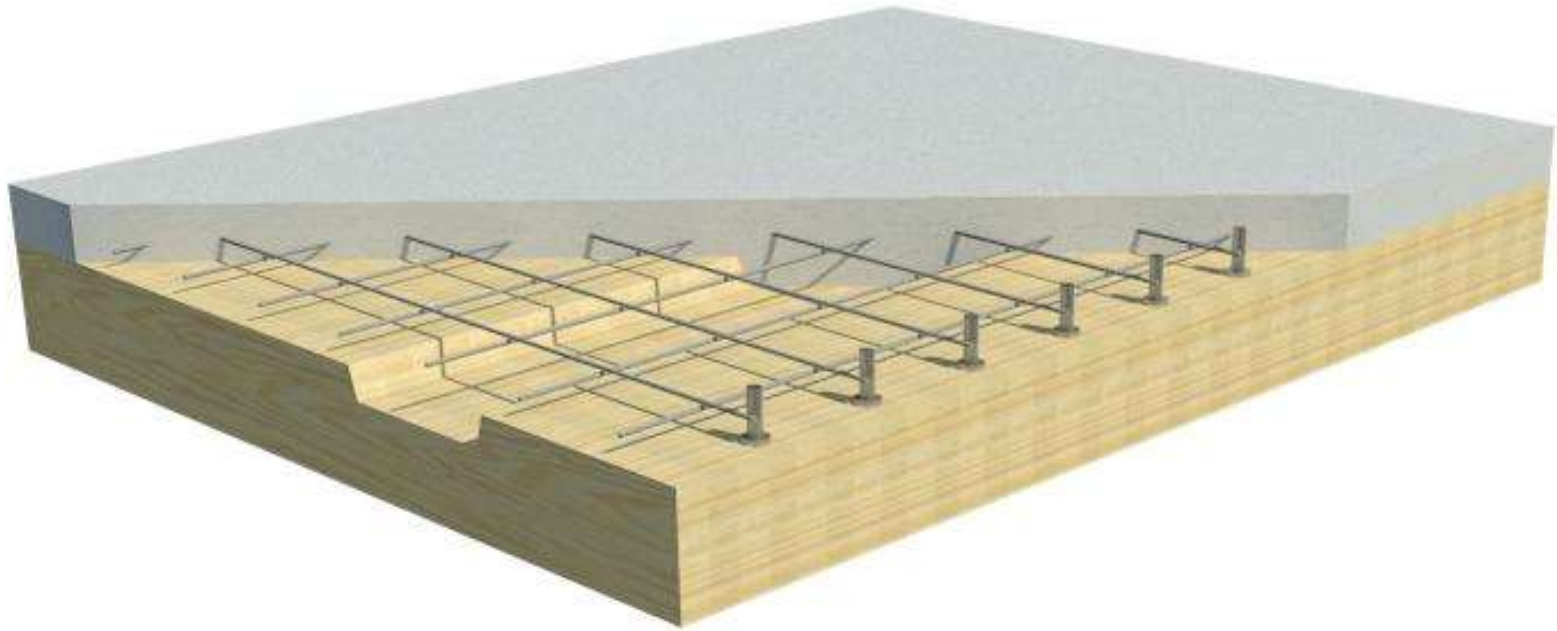

Wood – Concrete - Composite

Alternative

Names: Timber – Concrete – Composite

System: Solid wood panel at bottom, concrete over top (acting as one unit)

Base layer can be nearly any solid wood panel

Connector supplied by wood panel supplier or general contractor

“Free”, stiff and strong diaphragm

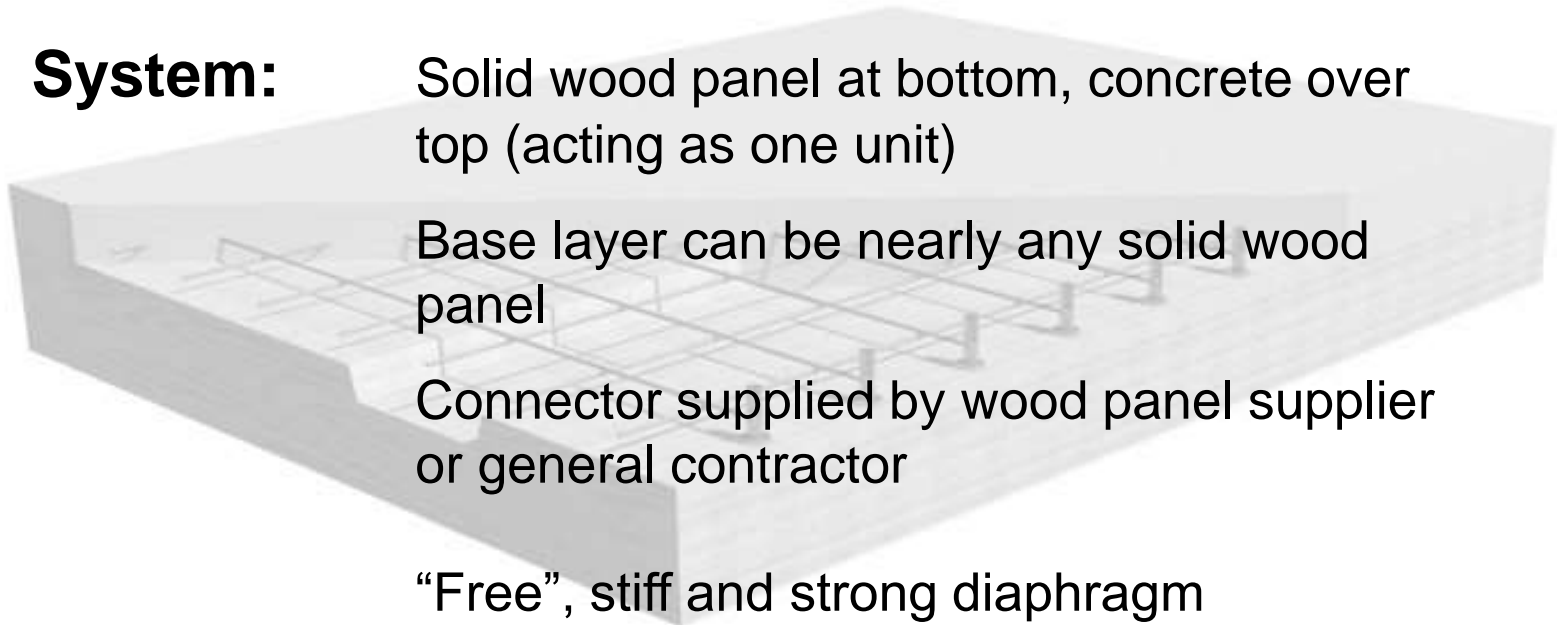

Overview | OTHERS

- PSL (Parallam)
- Solid Decking / T&G
- Logs

Sizes and Design Characteristics |

Sizes and Design Characteristics | Width

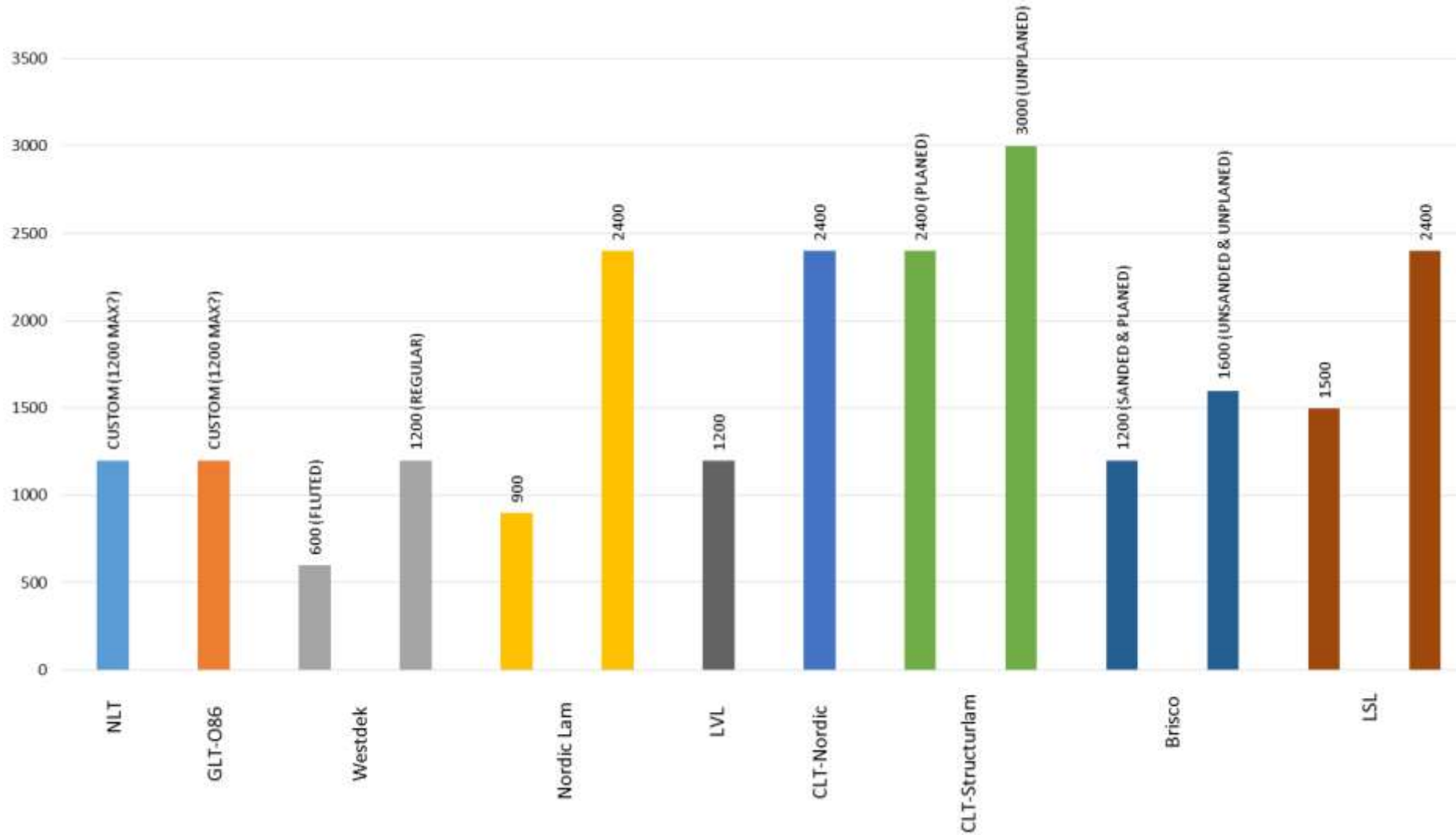

Sizes and Design Characteristics | Length

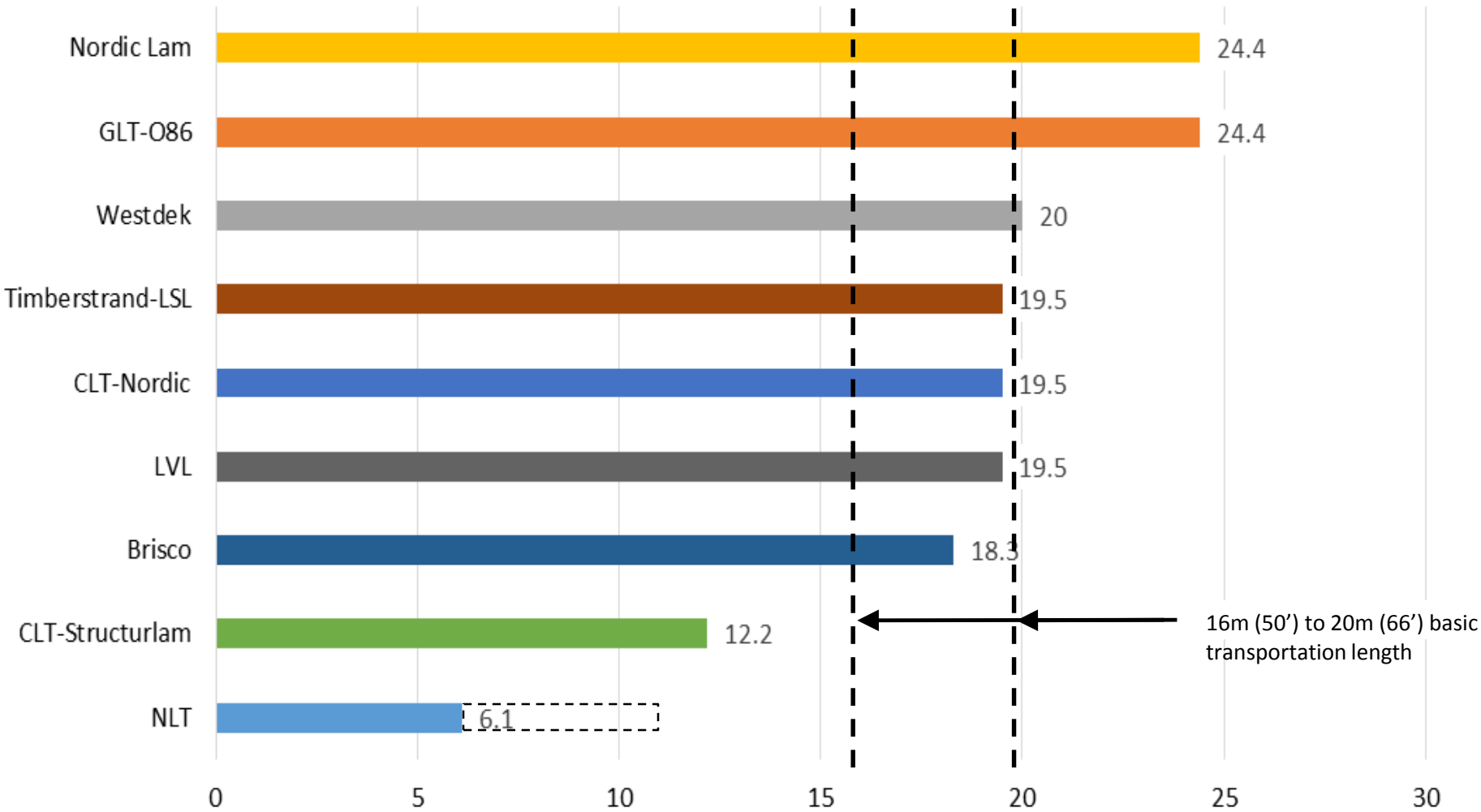

Comparison |

Comparison | **Stiffness**

Design is mostly governed by deflection (stiffness) and / or vibration

Stiffness |

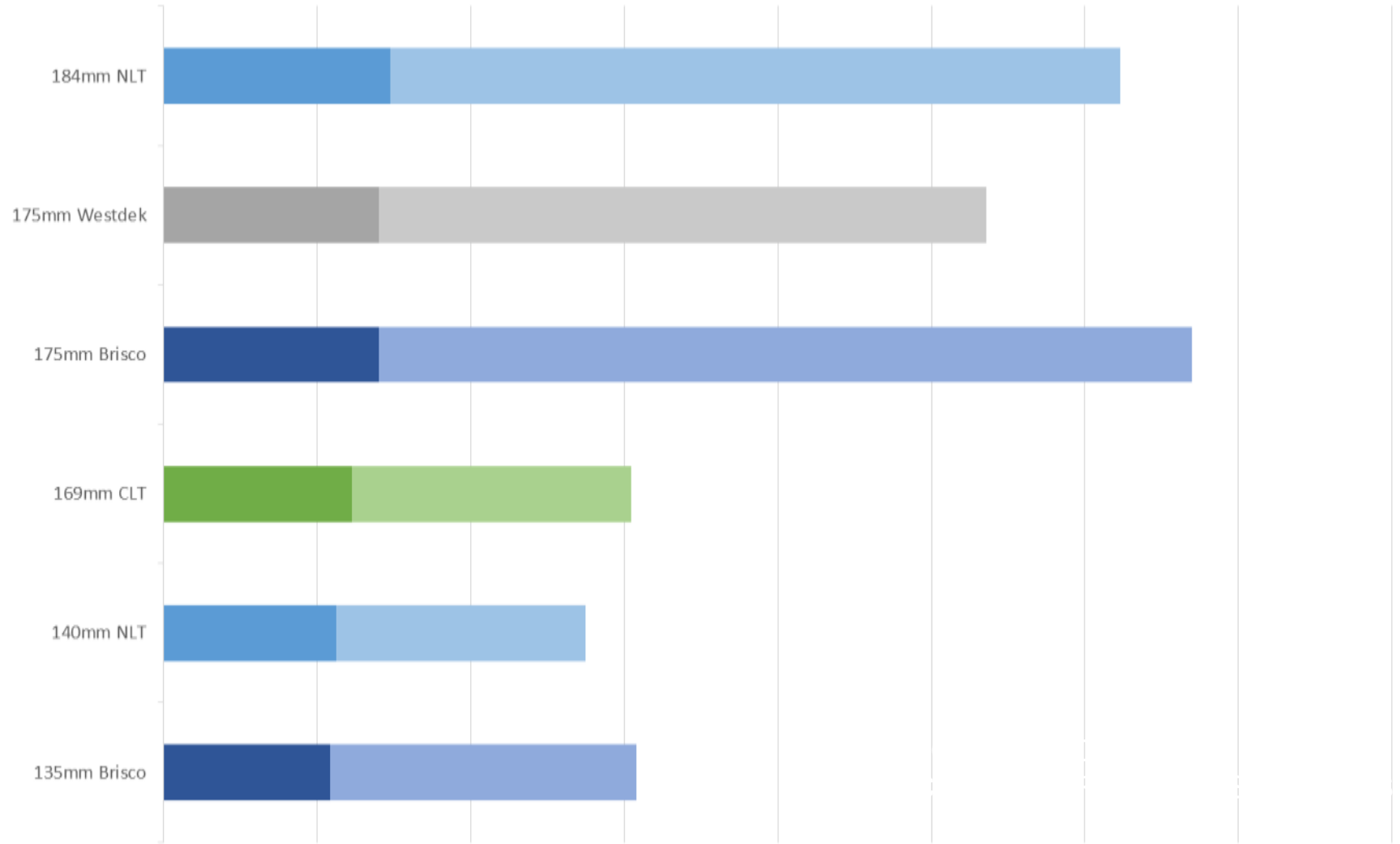

Comparison | Fire

- In general, all products have a similar char rate
- Approximately 38mm – 44mm / 60 minutes
 - Check with Code Consultant
- Be careful with CLT if required rating is between 45 and 90 minutes
 - Most of the time it's not a problem for panels with 5+ layers

Fire |

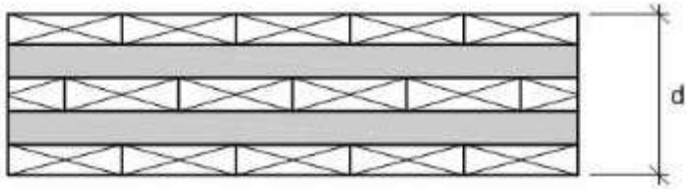

Fire |

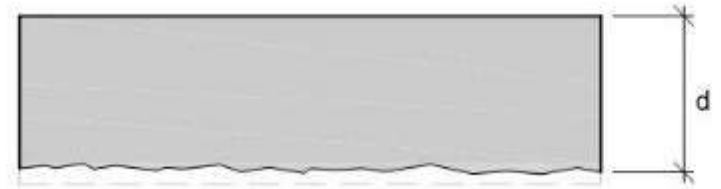
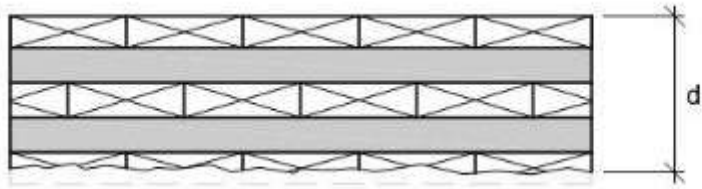

Fire |

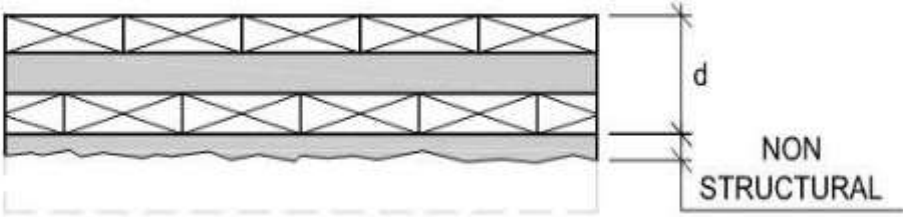

Practical Considerations |

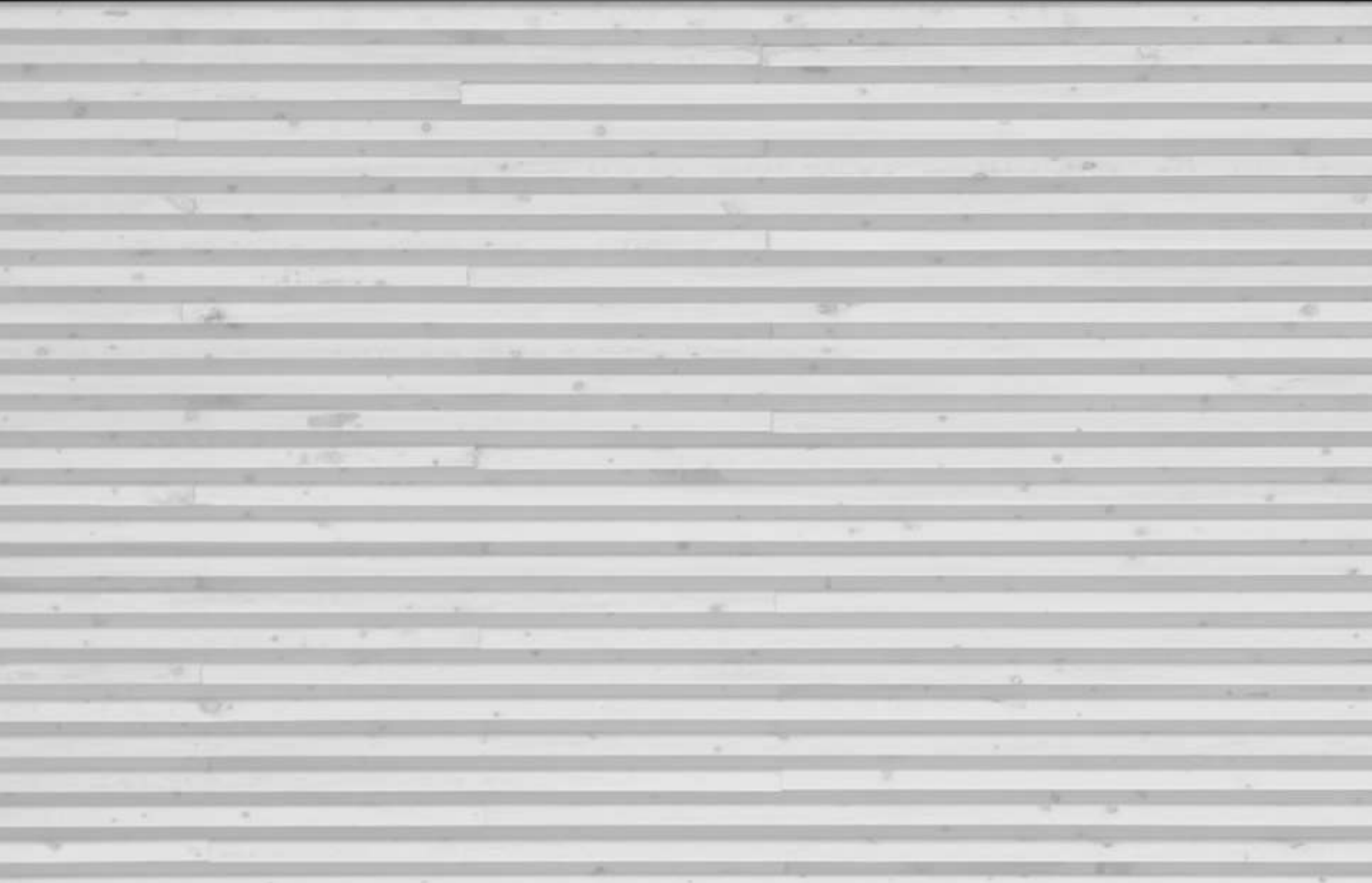

Practical Considerations | **Location**



Location |

- 
- Local trades
 - Distance to suppliers (LEED, Living Building Challenge)
 - Dry vs. wet climate
 - Funding
 - Season of construction (winter prefab)

Practical Considerations | **Size of a Project**



Size of Project |

- Sole Sourcing / Suppliers capacity
- Sequencing on Site / Staging
- Procurement

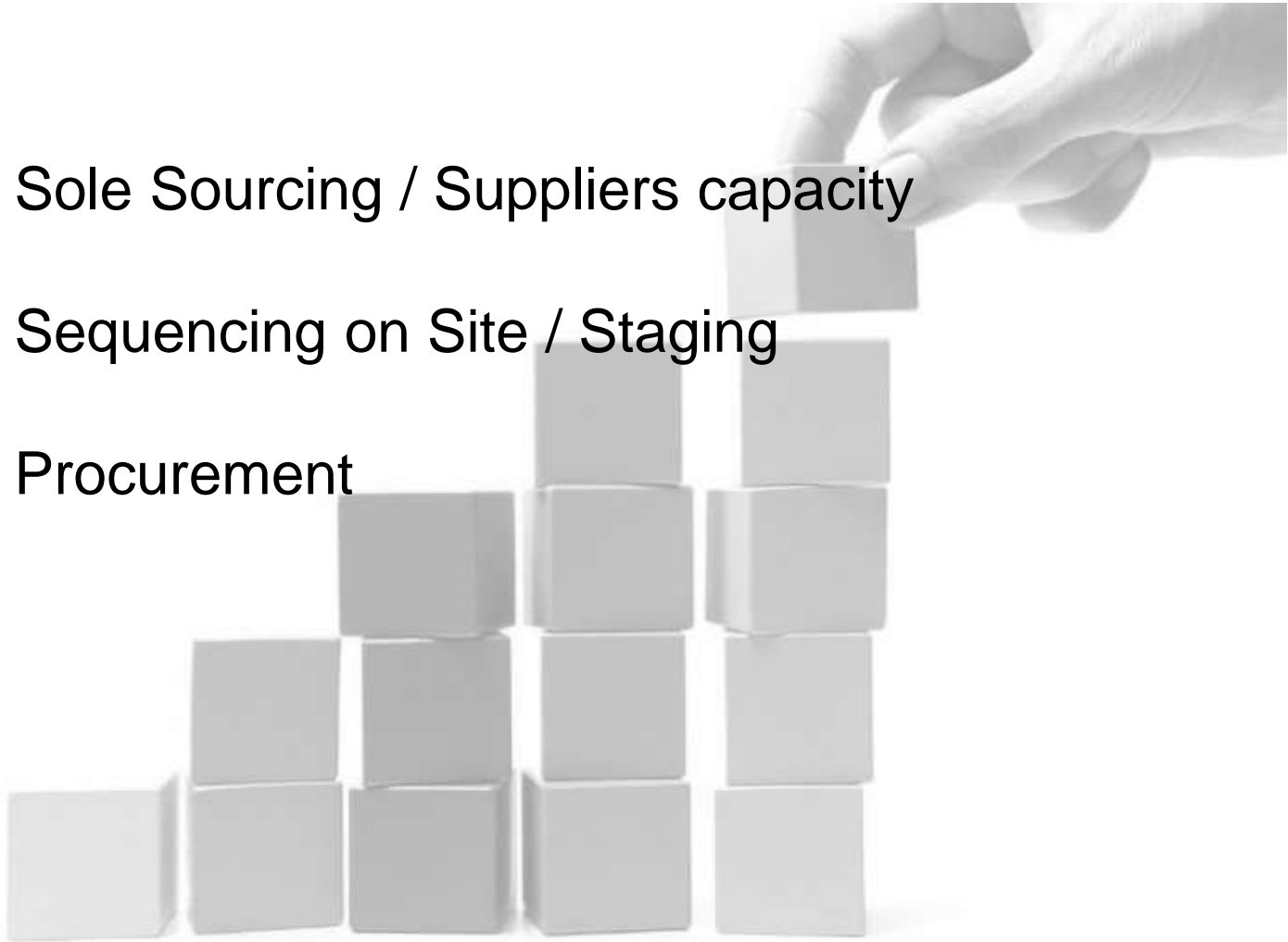

Practical Considerations | Procurement



Procurement |

- Design - Bid - Build
- Construction Management
- Design Build
- ?



Depth |

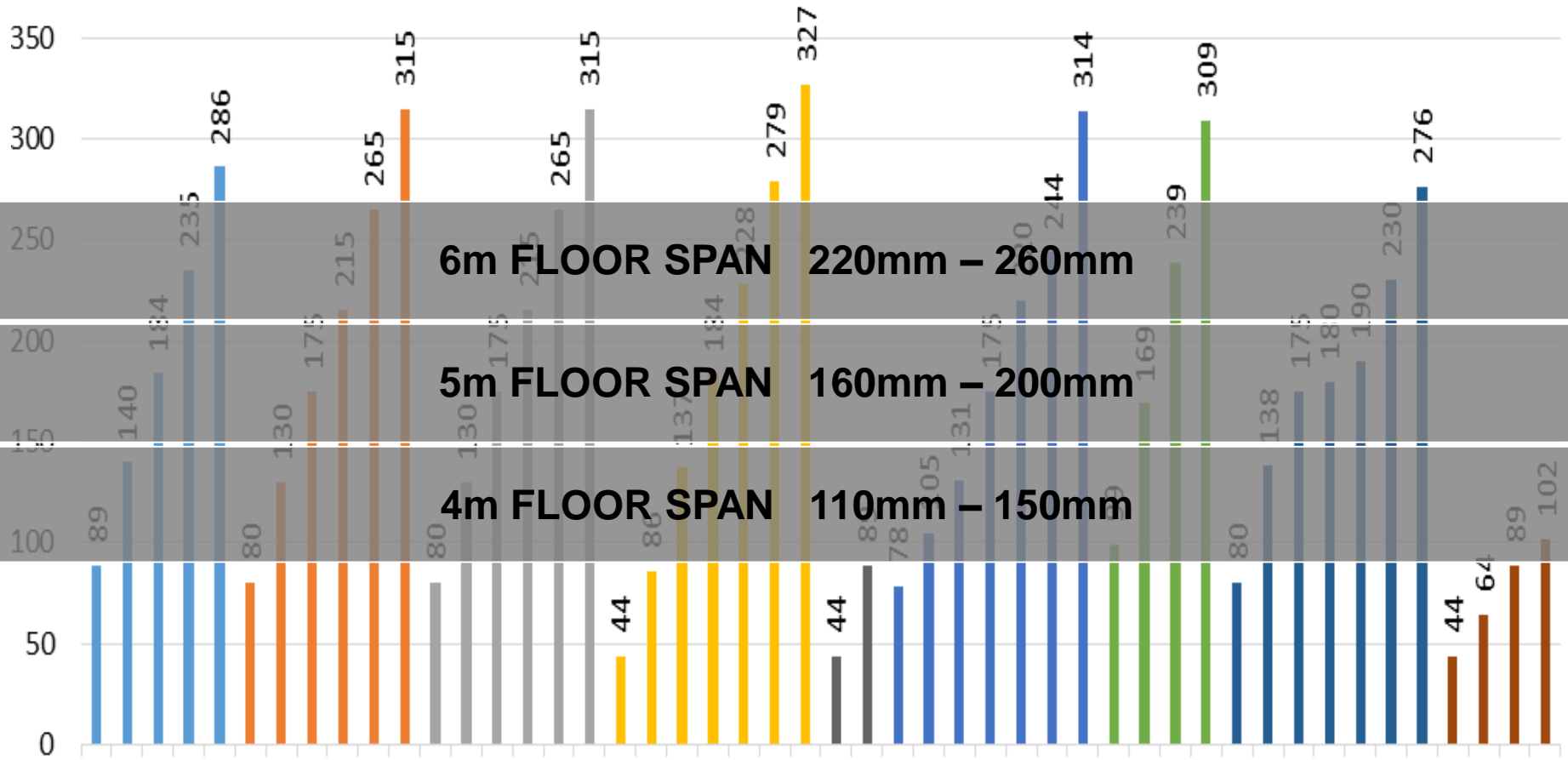

DEPTHS ACCOUNT FOR VIBRATION

Practical Considerations | **Decide Early**



Decide Early |

- Use the product to its fullest extent possible
- Work with supplier
- Economical solution

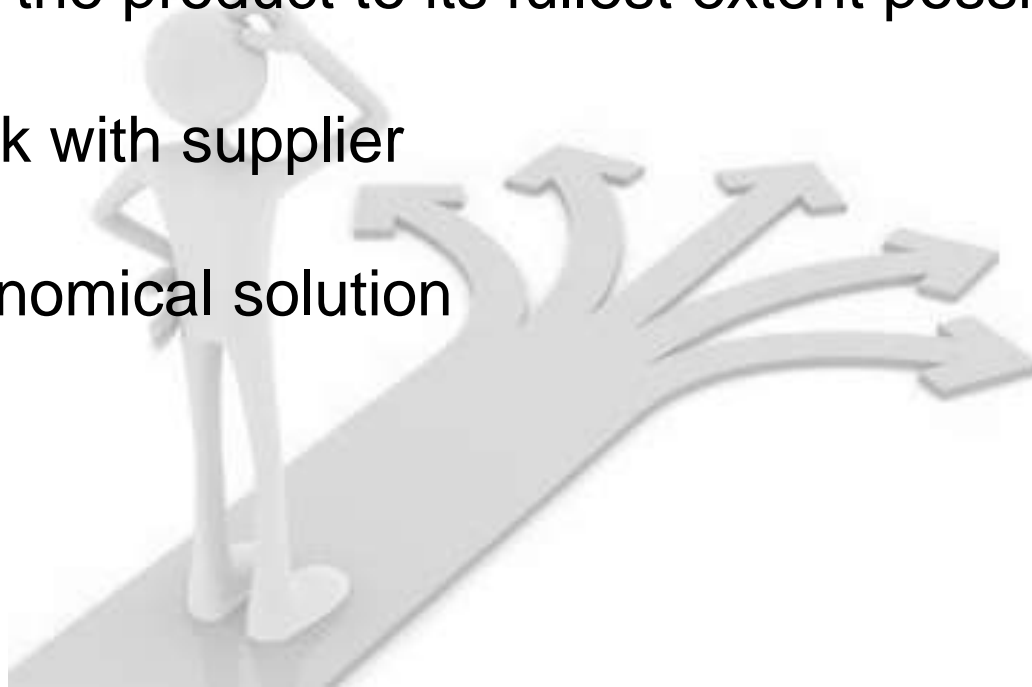

Practical Considerations | **BIM**

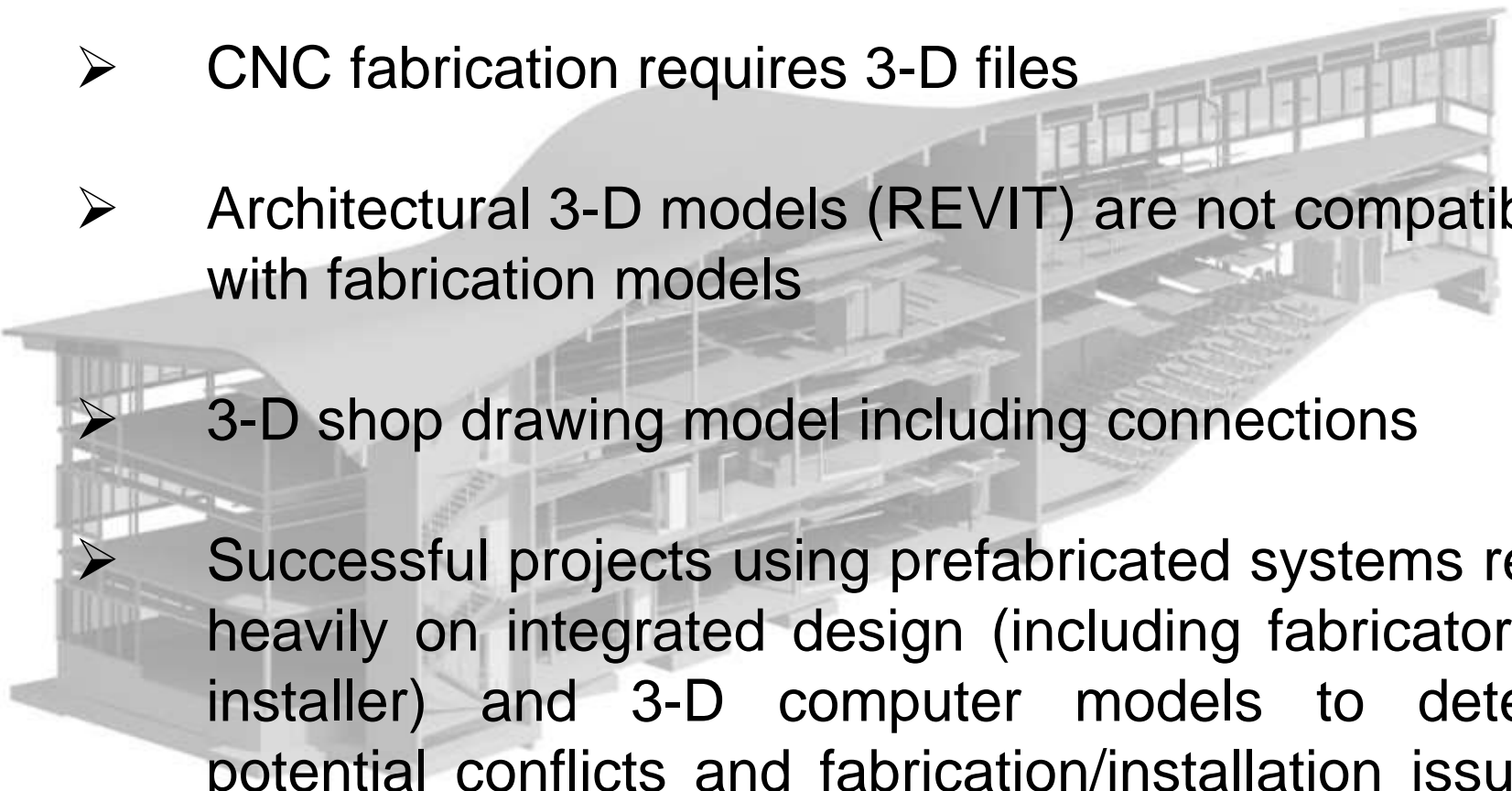

- 
- CNC fabrication requires 3-D files
 - Architectural 3-D models (REVIT) are not compatible with fabrication models
 - 3-D shop drawing model including connections
 - Successful projects using prefabricated systems rely heavily on integrated design (including fabricator & installer) and 3-D computer models to detect potential conflicts and fabrication/installation issues early in the process

Practical Considerations | Movement

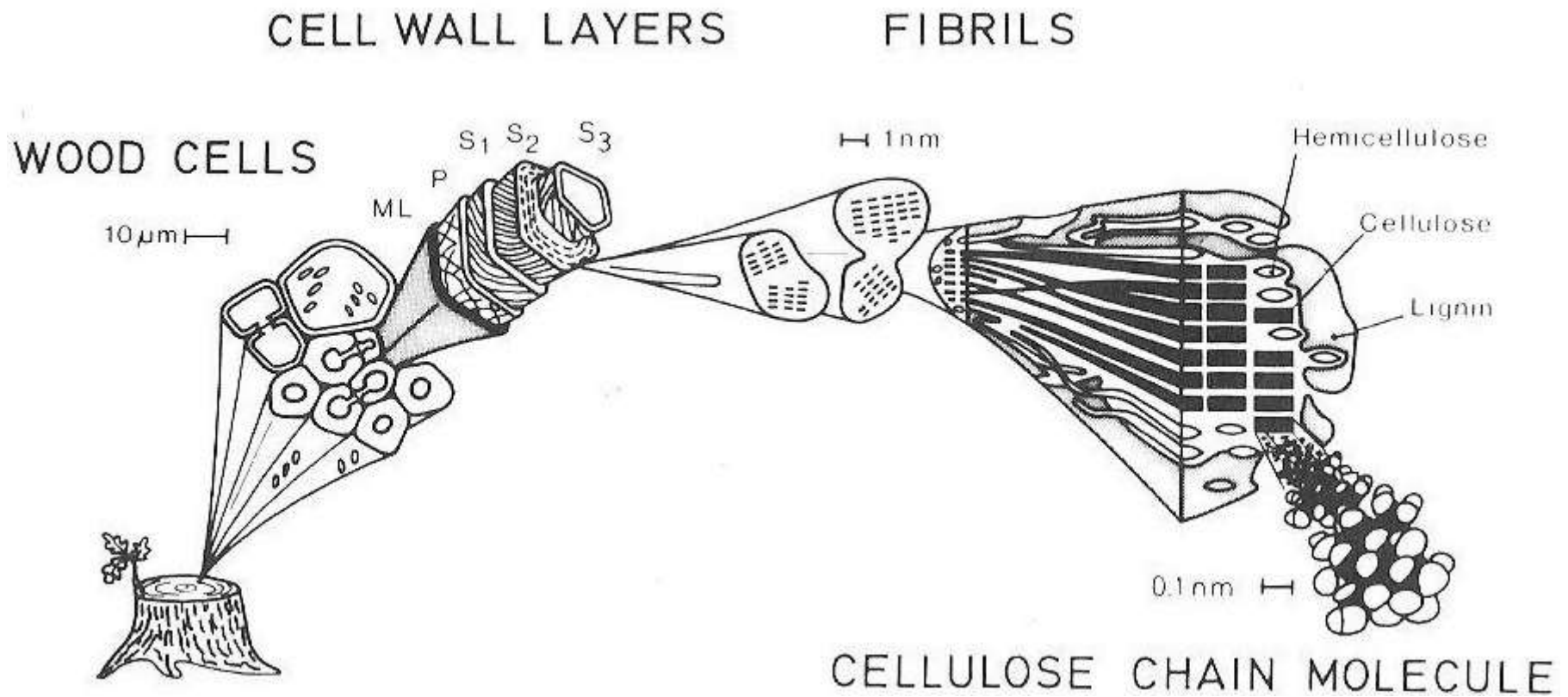

Practical Considerations | Movement

NLT, GLT:

0.25% change in dimension for each **1%** change in moisture content

- 12%MC when installed
- 14%MC during construction
- 50mm swelling in 10m

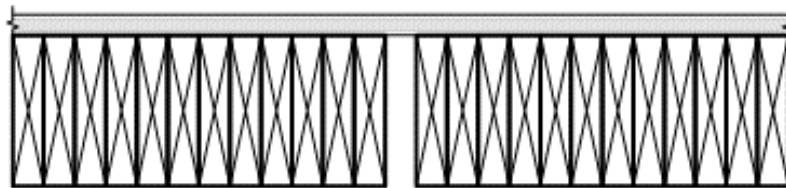

38 OR 76
(1 OR 2 LAMINATION)
GAP TO BE FILLED IN AFTER
BUILDING IS ENCLOSED.
GLUE OR PIN NAIL.

*38mm each 6m (1 ½" each 20')

Practical Considerations | Connections

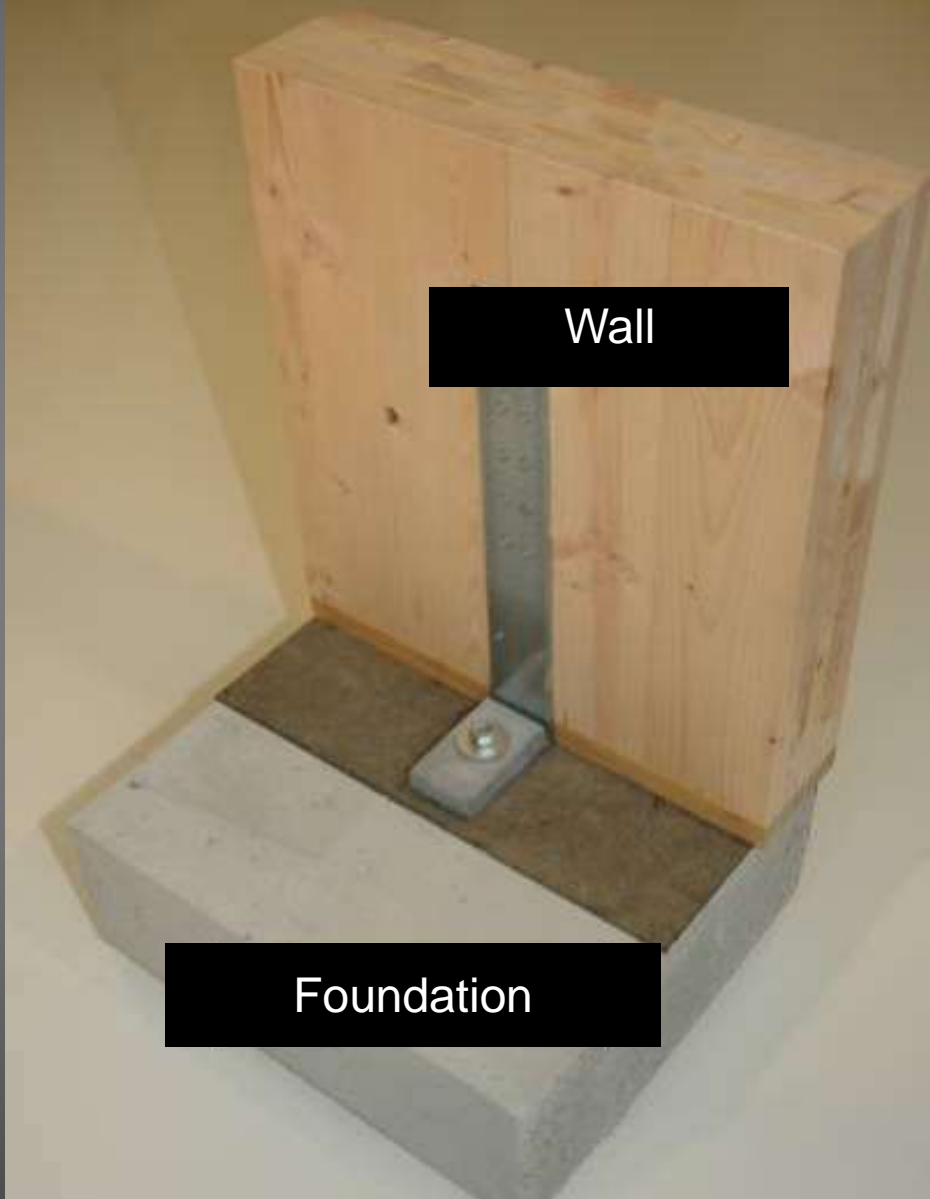
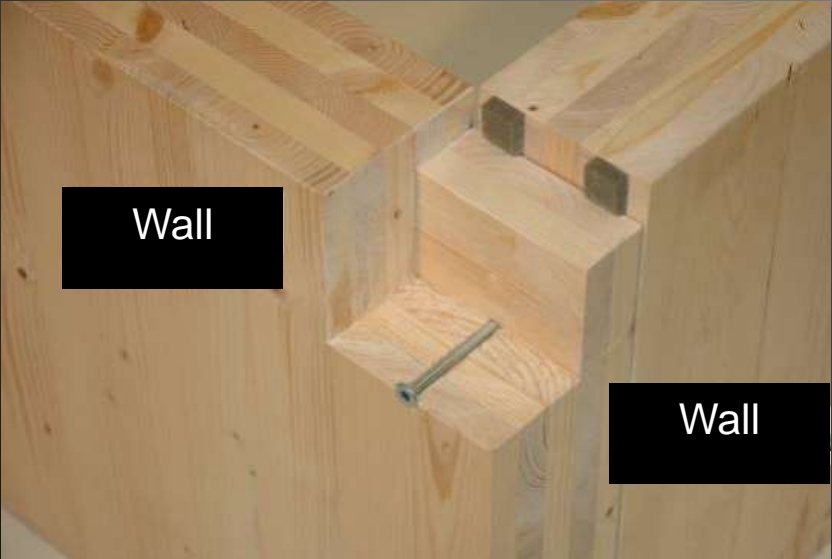
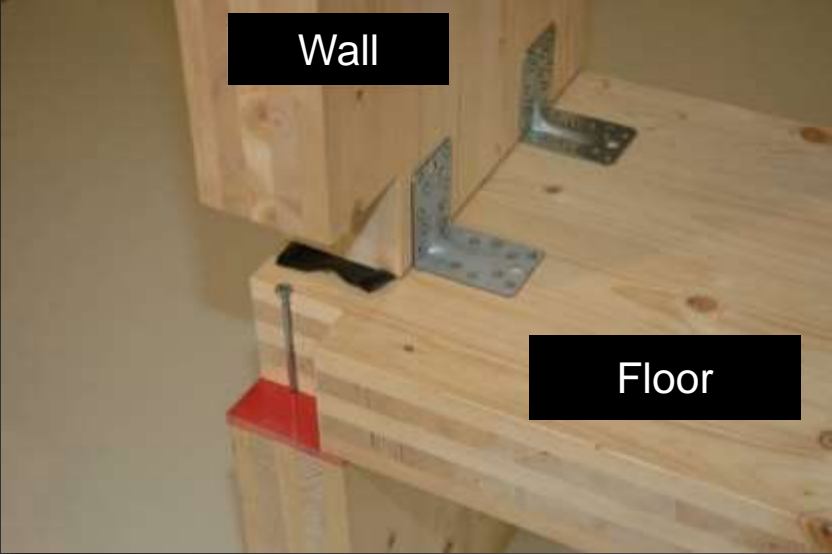

Practical Considerations | Connections

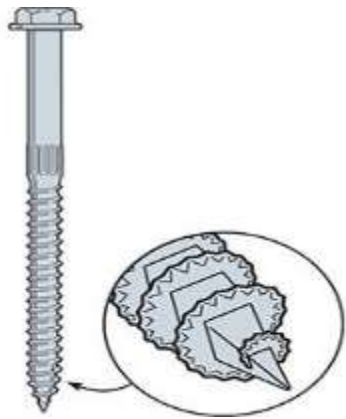

Practical Considerations | Connections

Galvanized or otherwise protected steel parts and fasteners to deal with moisture:





Mass Timber Design Process|

- Case studies as a means to introduce concepts, uses and challenges:
 - Case 1: Athabasca University Academic Research Ctr.
 - Case 2: Mountain Equipment Co-op Head Office

Case Study One | Athabasca University

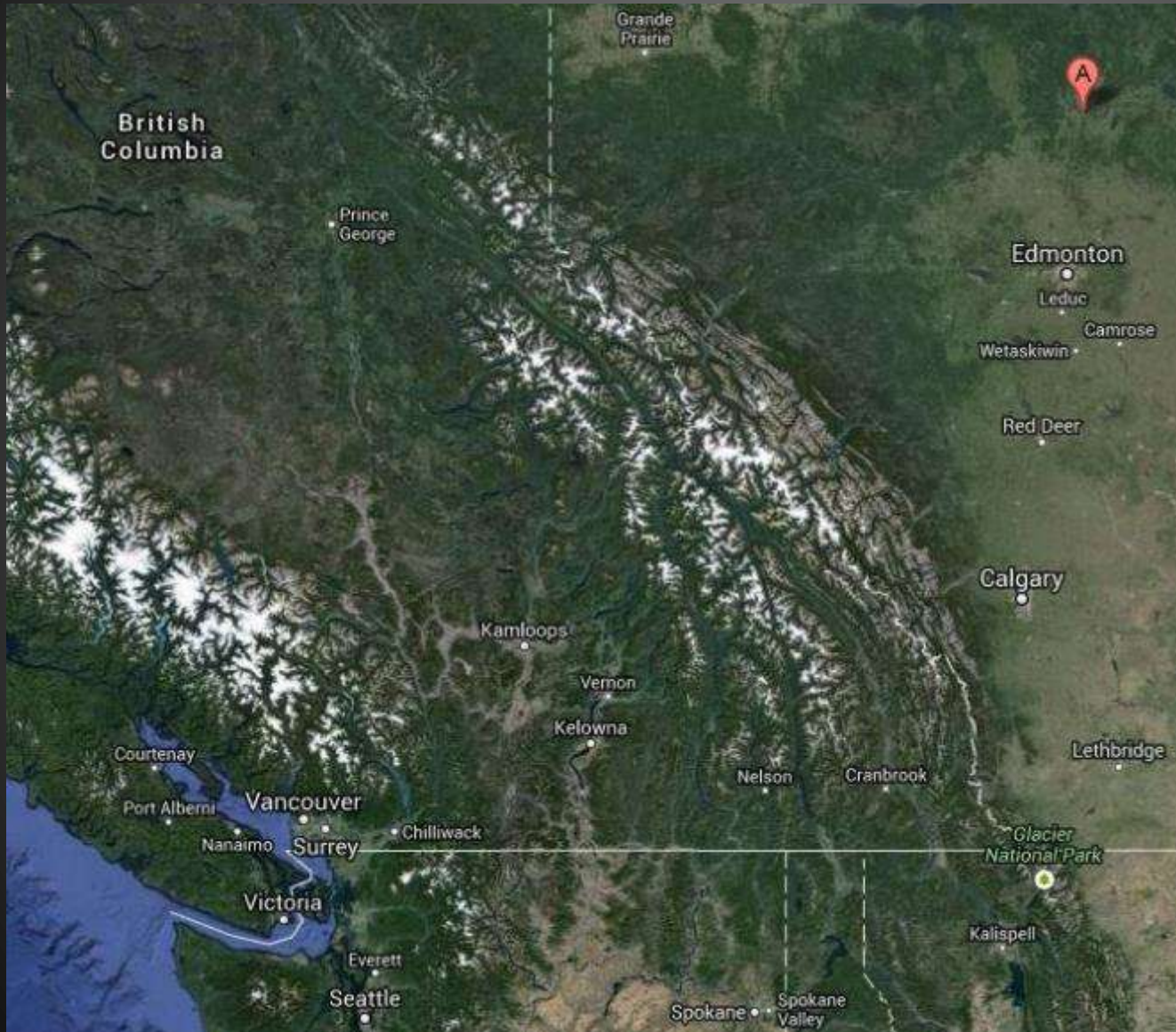

Design |







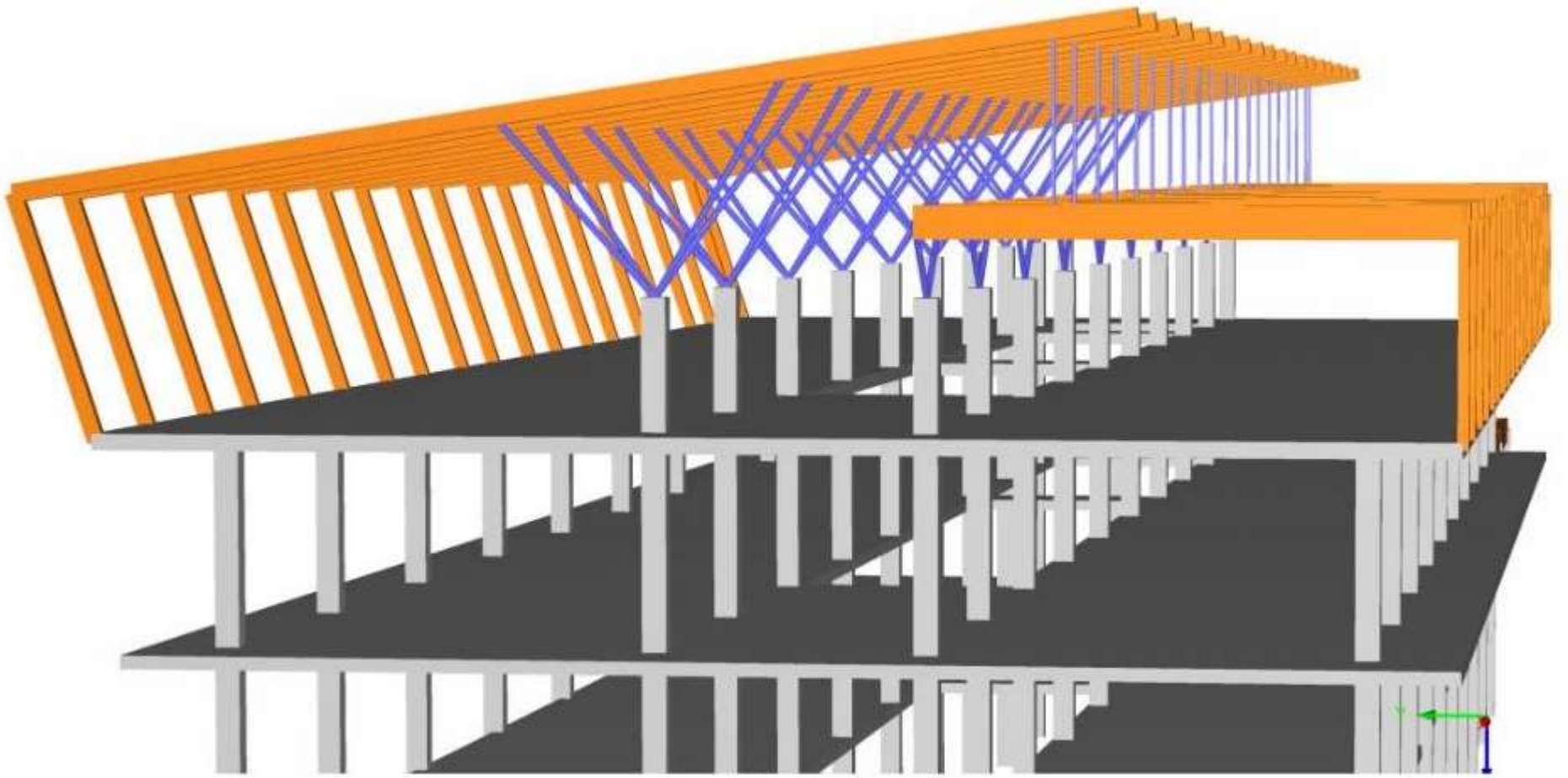

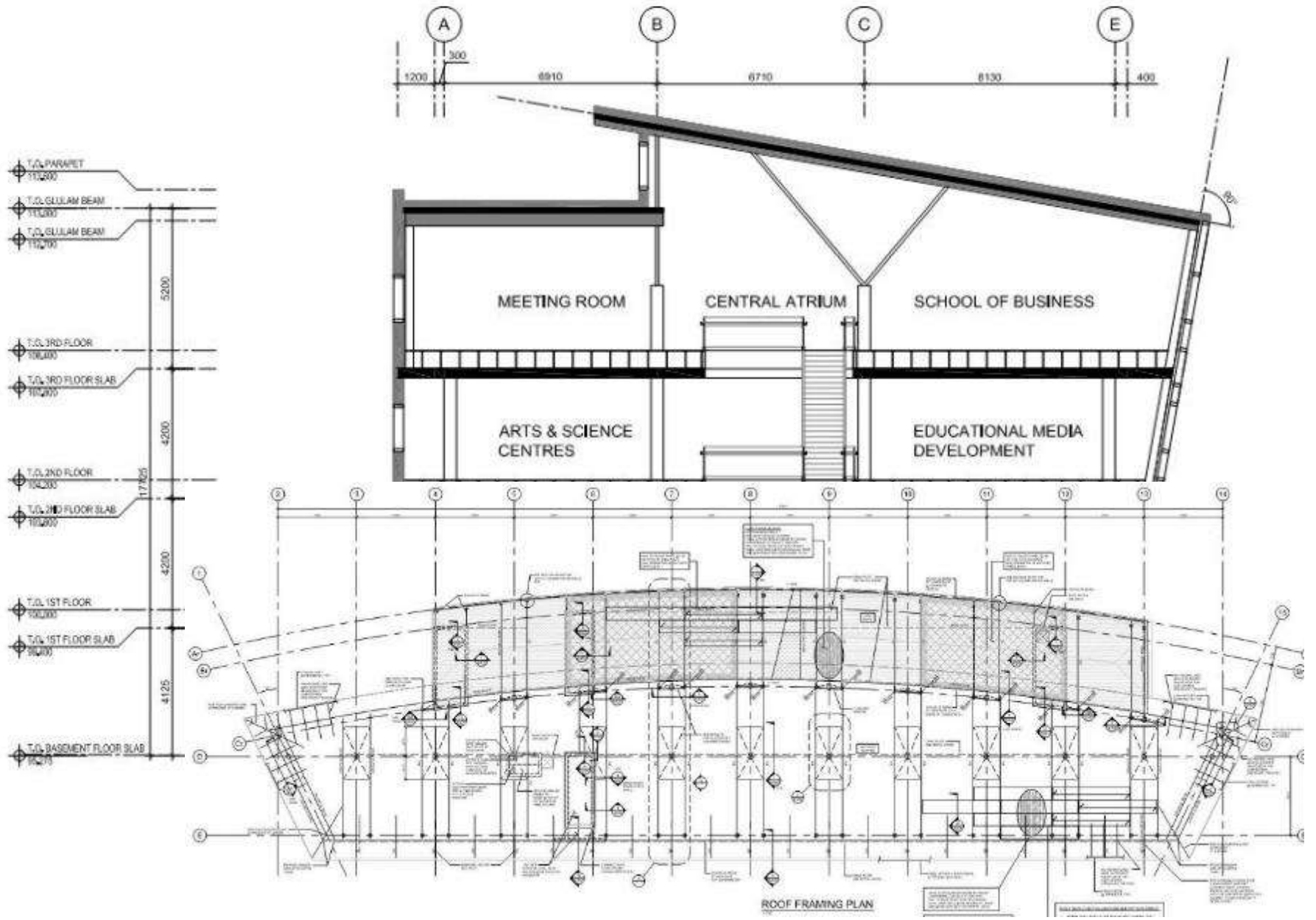

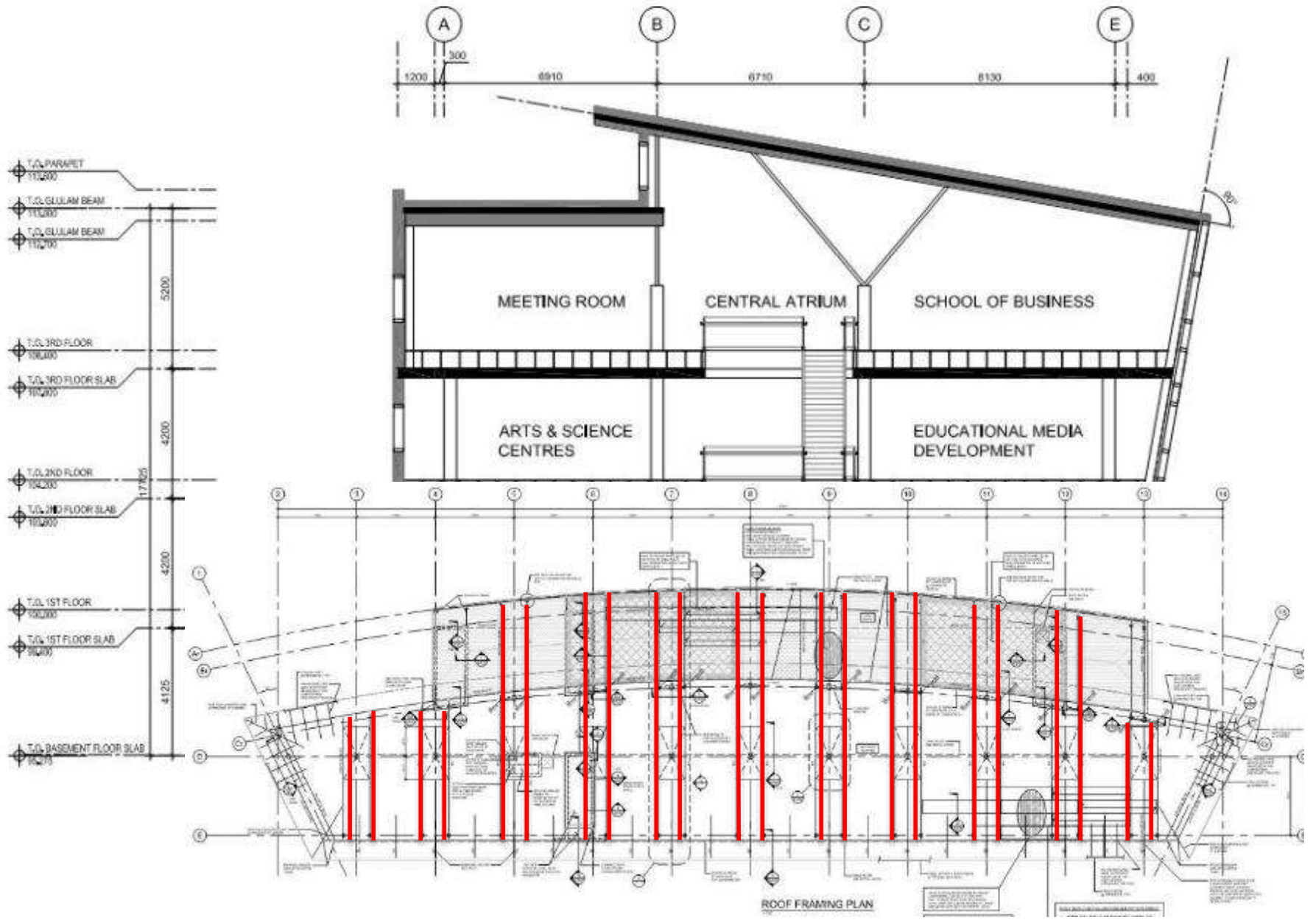



Nail Laminated |

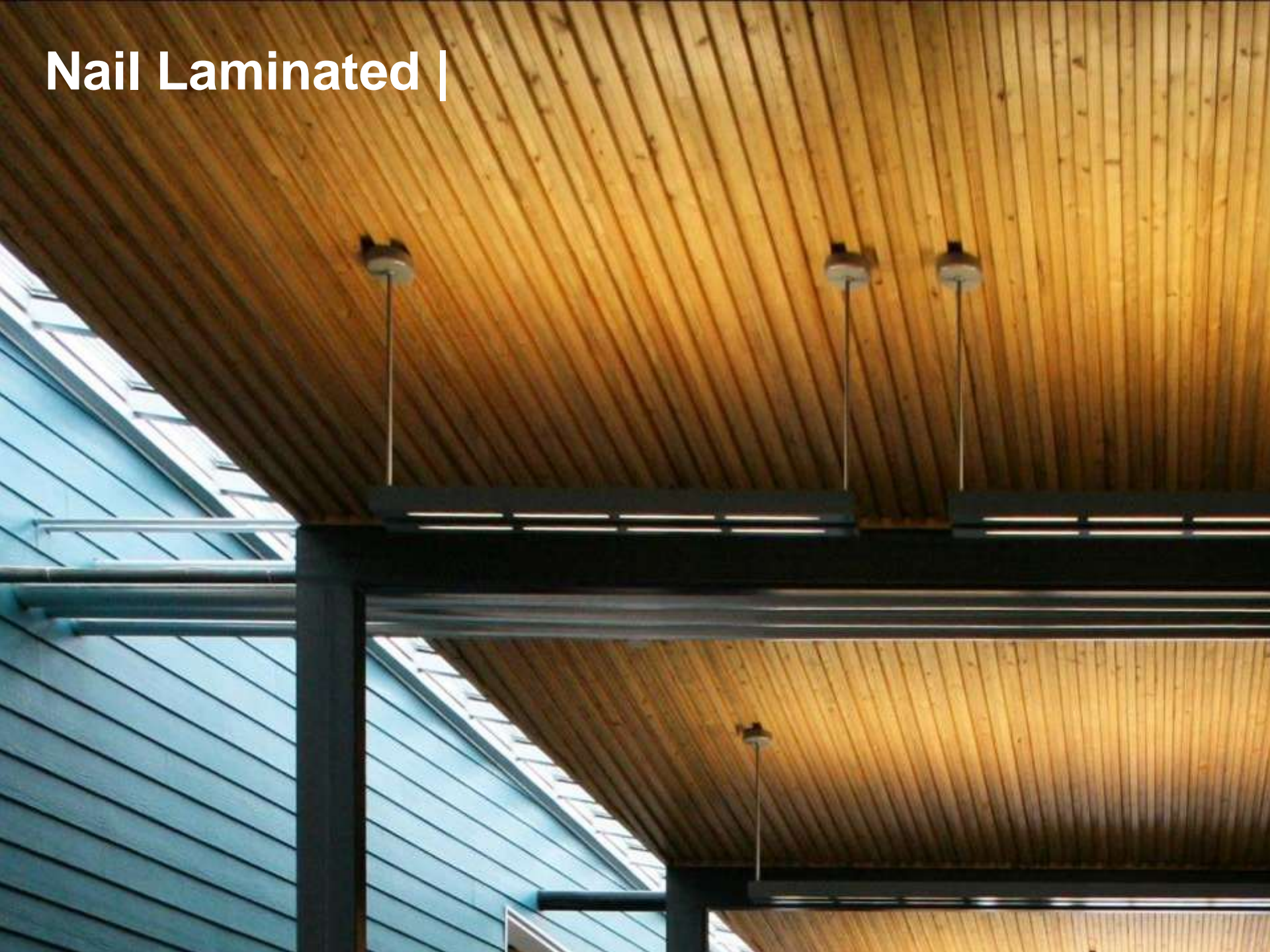

Nail Laminated |

- Standard & locally available
- Prefabrication
- Aesthetics
- Low-skilled labour
- Integrates mechanical & electrical systems

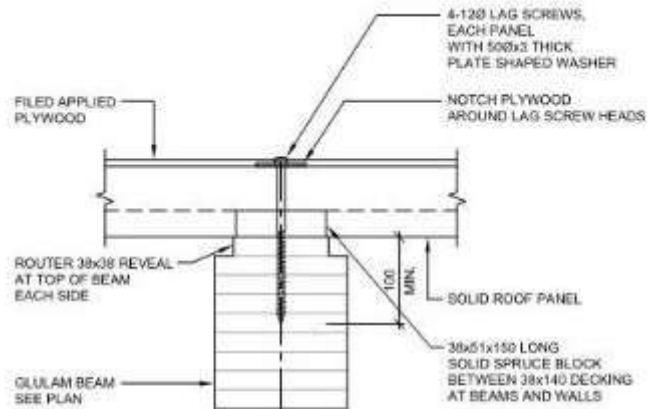

7 TYP. PANEL CONNECTION
1:10

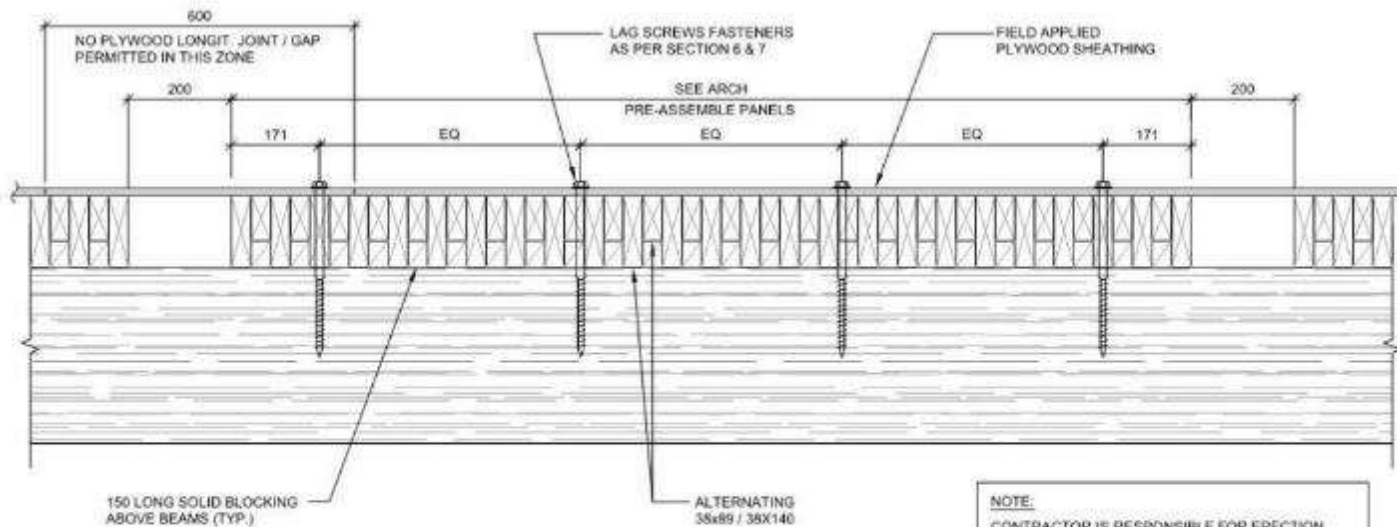

NOTE:
CONTRACTOR IS RESPONSIBLE FOR ERECTION AND STABILITY OF PANELS DURING CONSTRUCTION. DISCUSS ERECTION PROCEDURE WITH ENGINEER PRIOR TO FABRICATION

A DETAIL
S205 1:10

Tender & Construction |











SOPREMA

RAVAP'R









Case Study Two | Mountain Equipment Co-op



PROSCENIUM
ARCHITECTURE + INTERIORS INC.





Design |





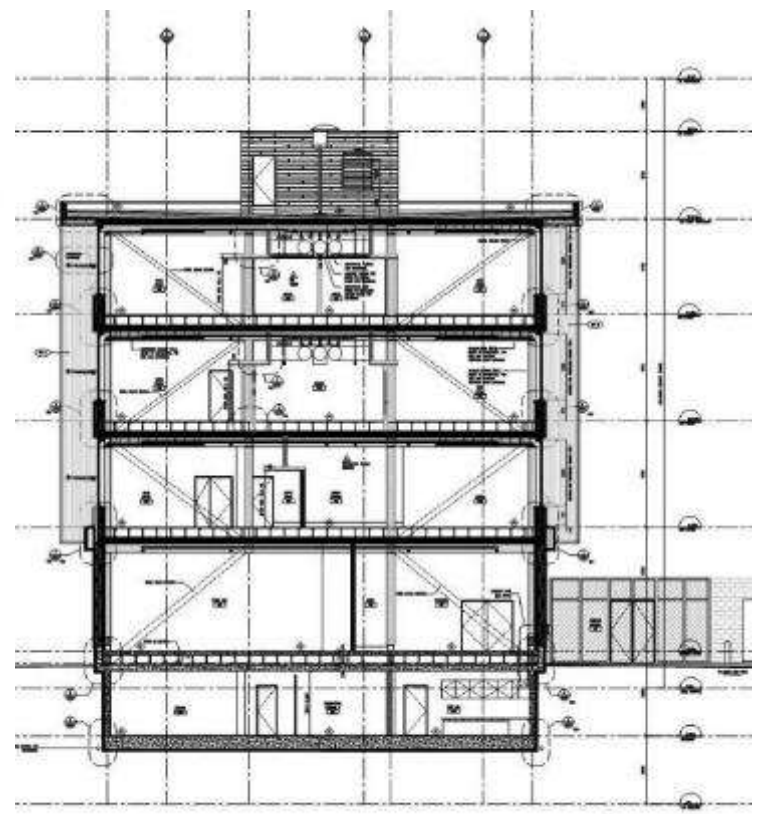
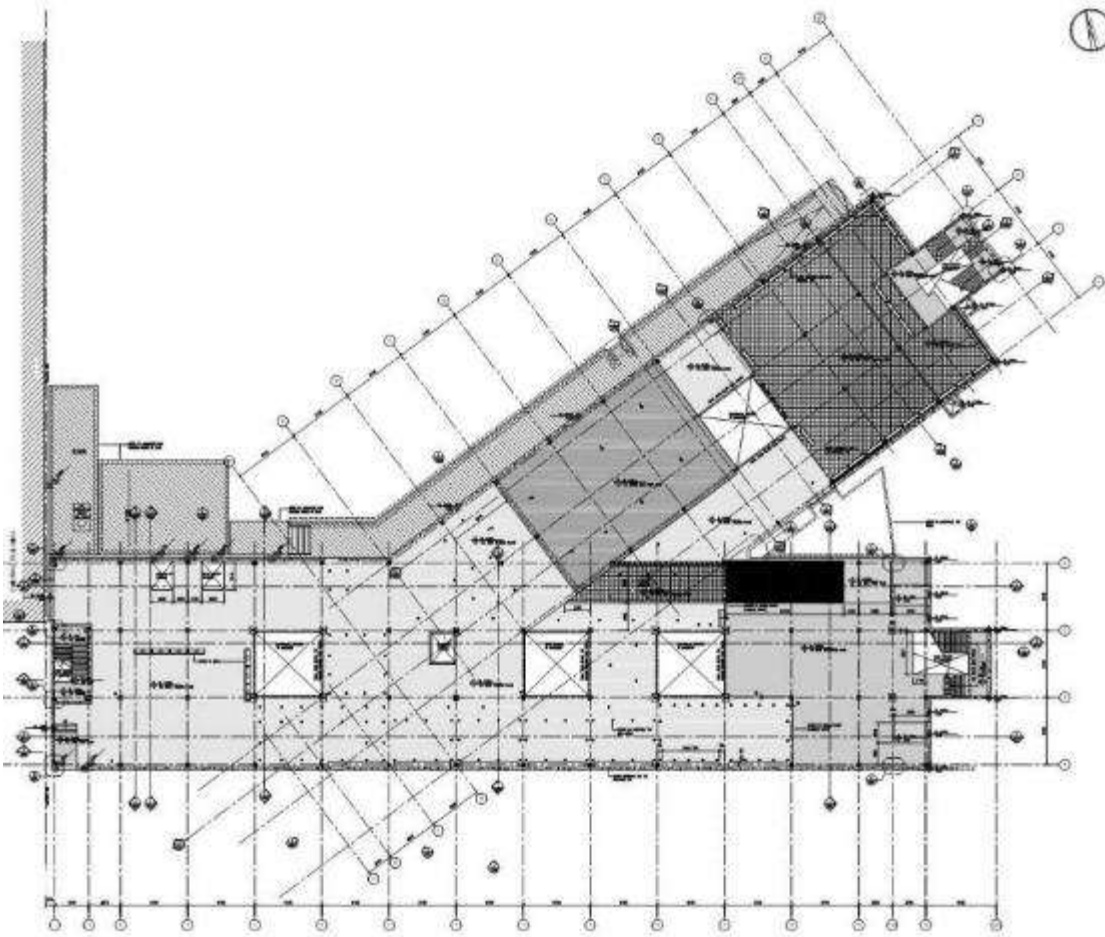

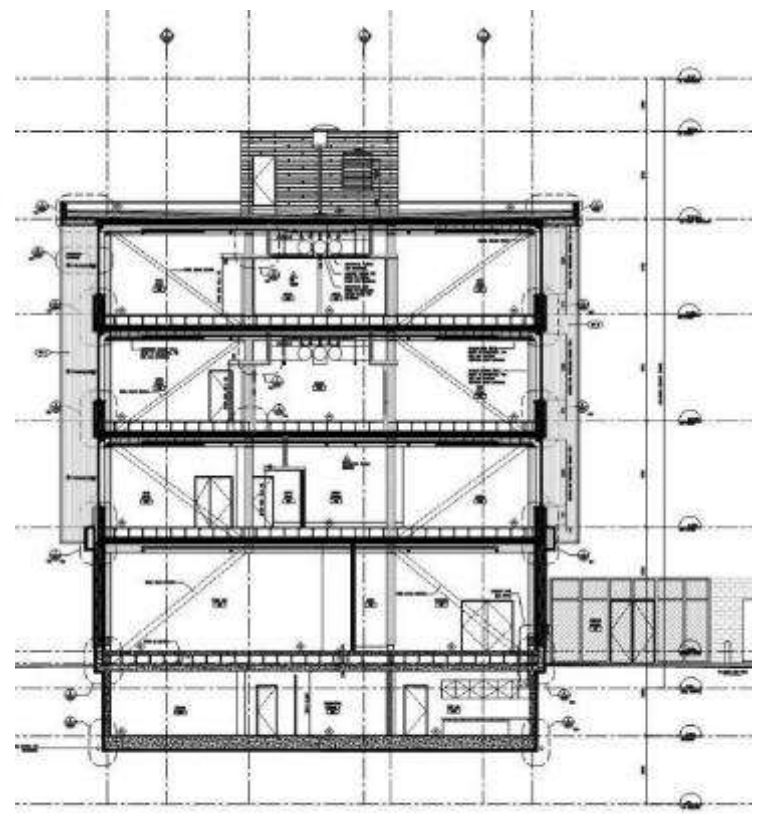
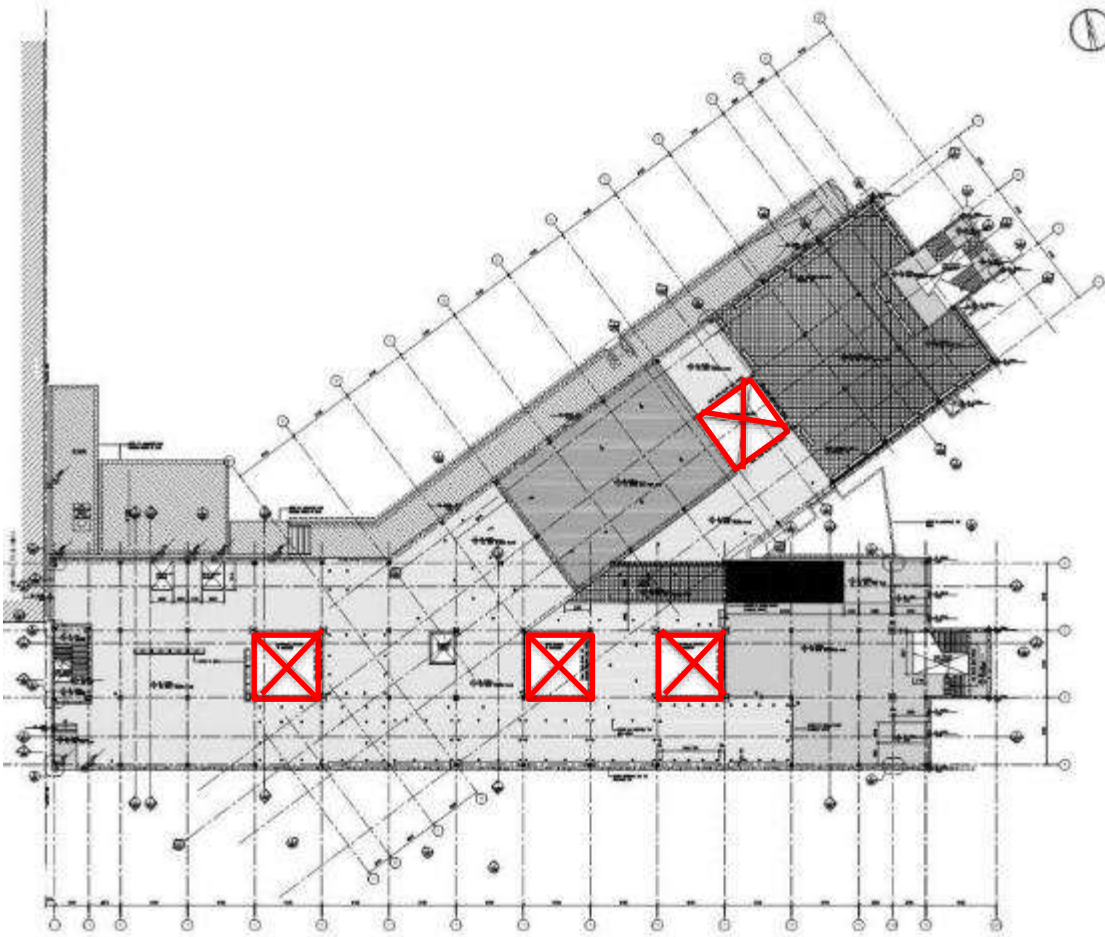

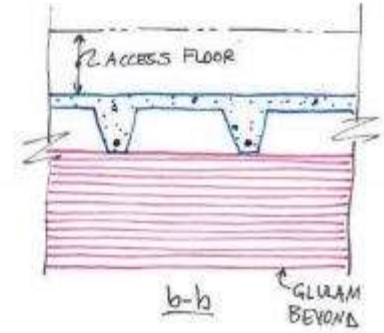
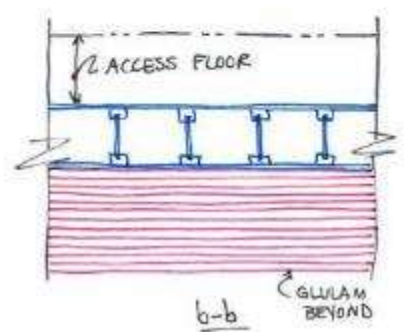
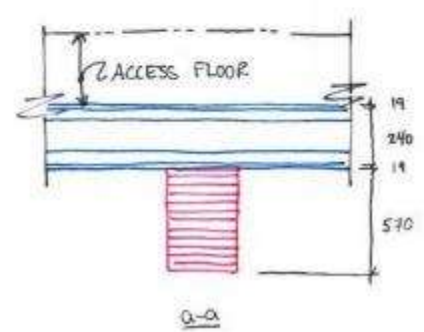
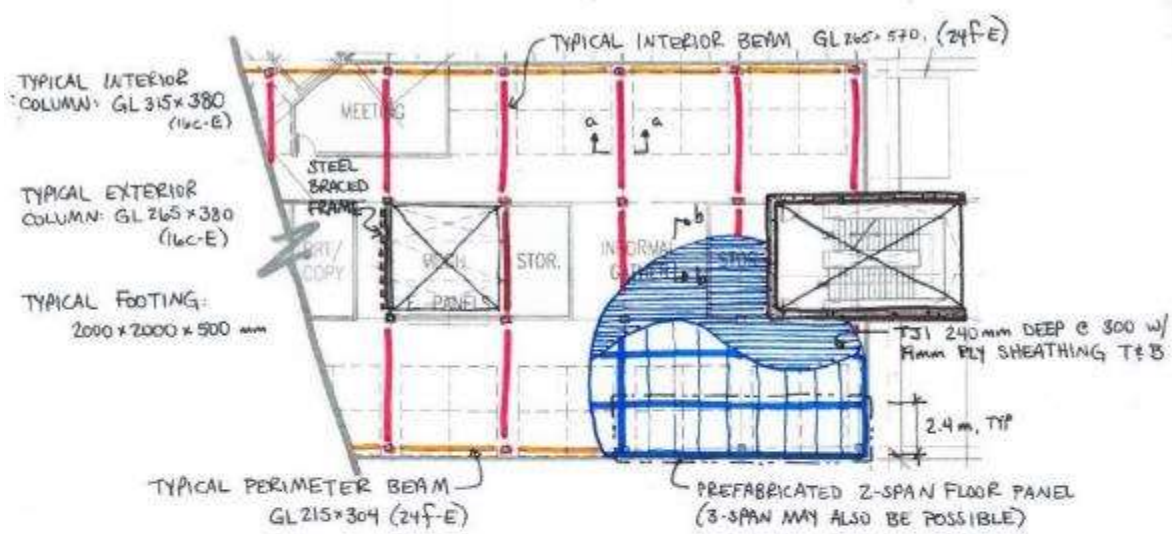

1778
 MEC-H0
 GLULAM/TJI FLOOR
 F+E/TL
 06 OCT 2011

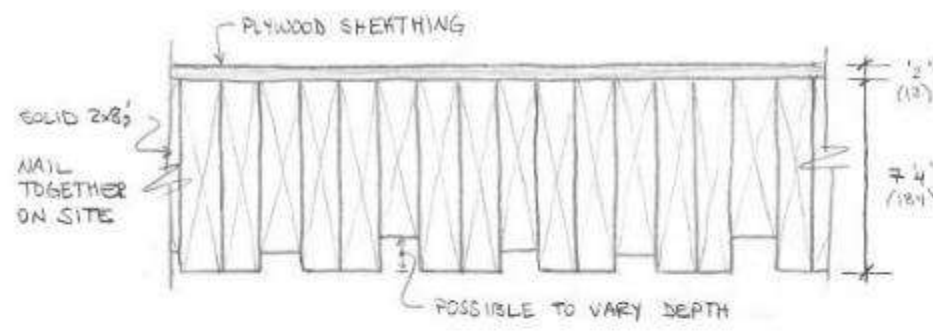
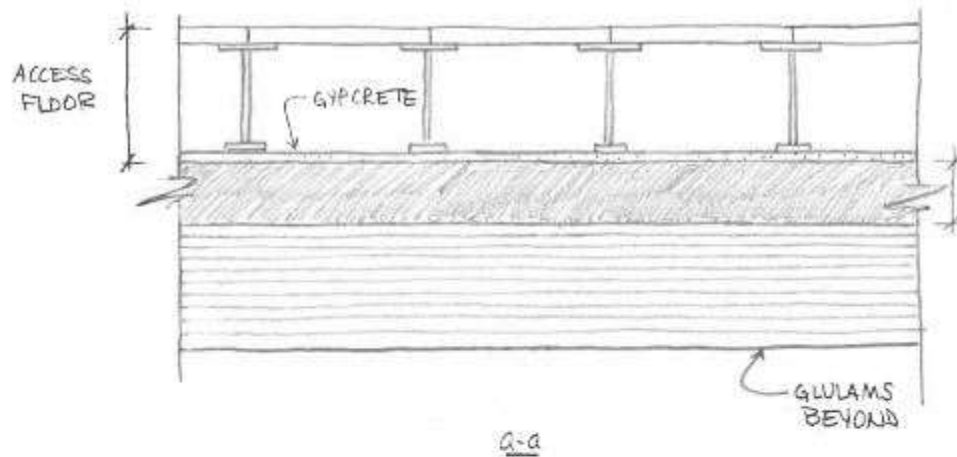

NLT

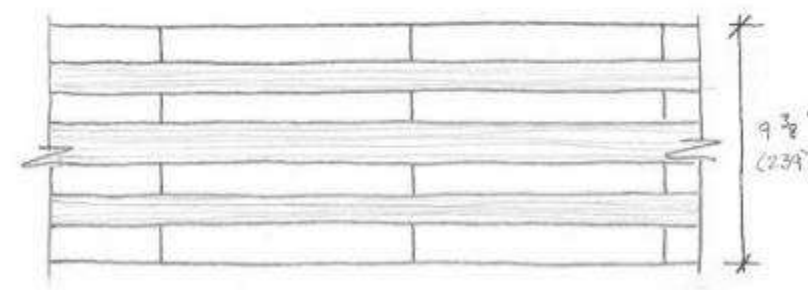
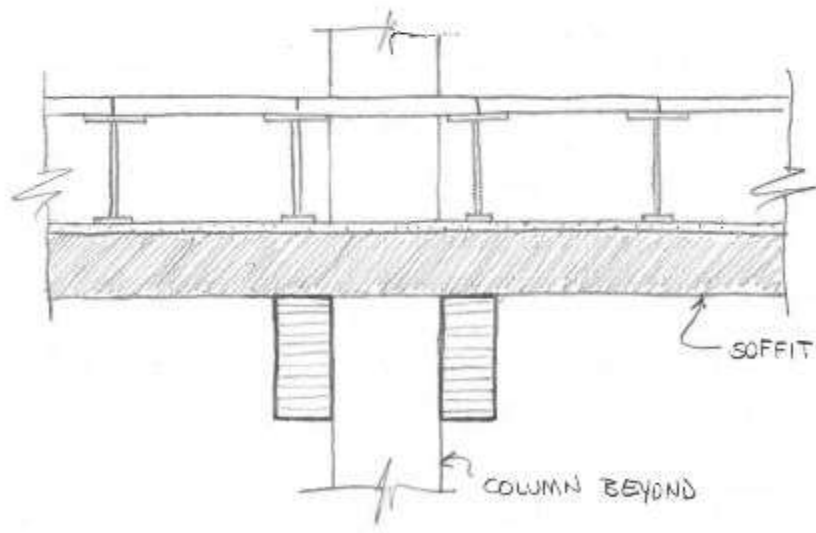

CLT

Tender |

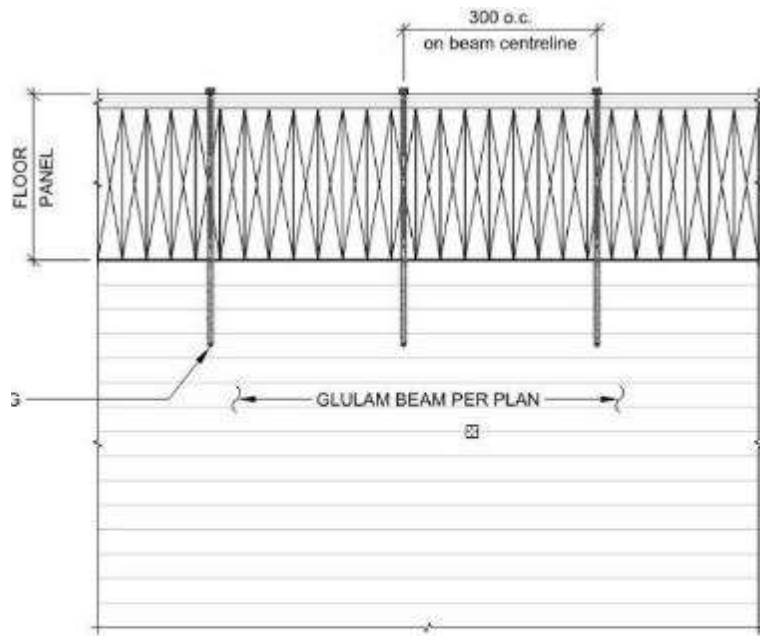

- 2x8 solid wood NLT panels
- 2x10 panels at snow drift zones and green roof
- Random stack pattern for long span
- 1/2" plywood and topping
- One hour fire rating (including char reduction)

7 TYP. CONNECTION -
PANELS TO GLULAM BEAMS
1:10

Construction |











senoate

VANCE TRUSS LTD

20
11-11-17
D.F.



ALLIANCE TRUSS

ALLIANCE TRUSS

ALLIANCE TRUSS

S LTD











The Future of Mass Timber |



The Future | Innovative Products + Applications

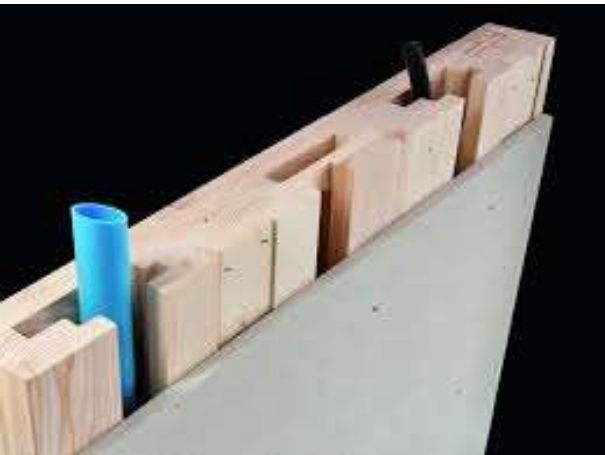
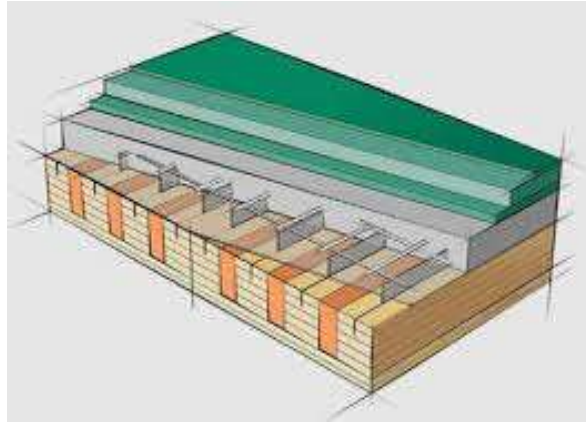

The Future | Innovative Products + Applications

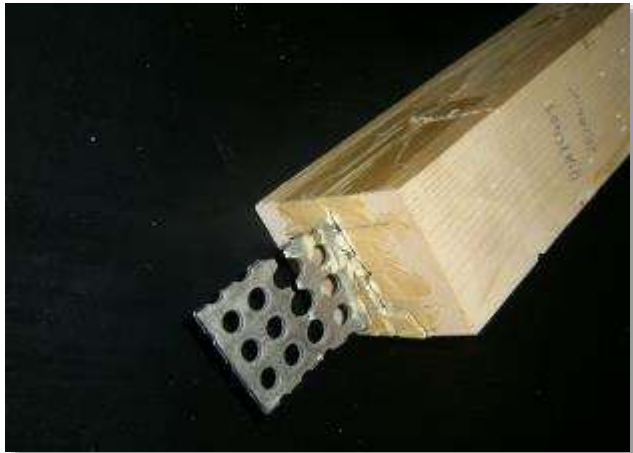

The Future | Procurement

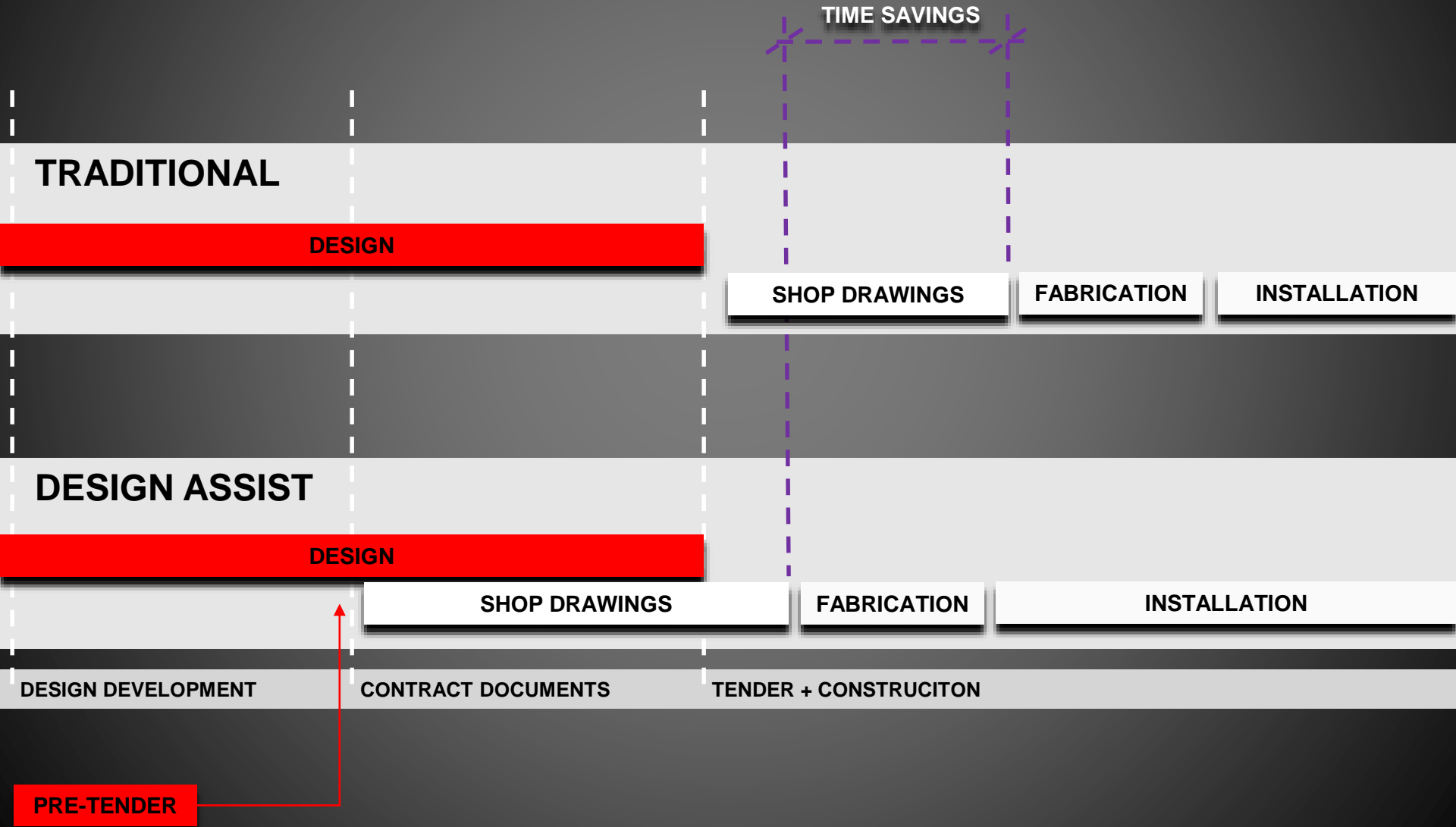

The Future | Tall(er) Wood Buildings

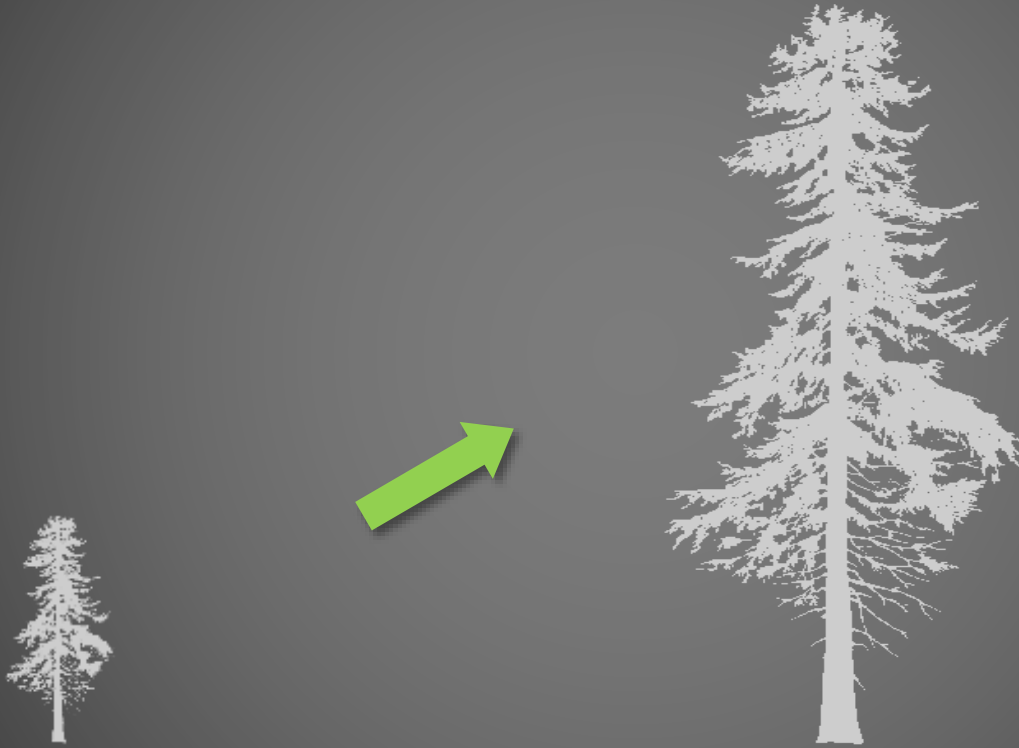



CONCEPT App |

- Idea calculator for architects
- Member calculator
- Material gallery



CONCEPT App | Depth Calculator

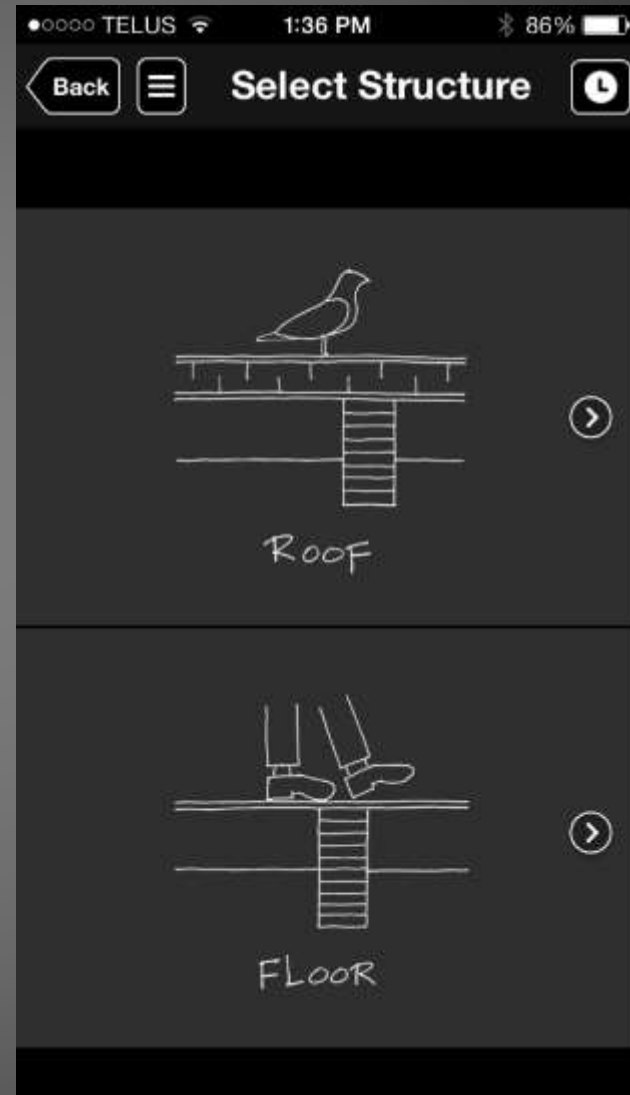
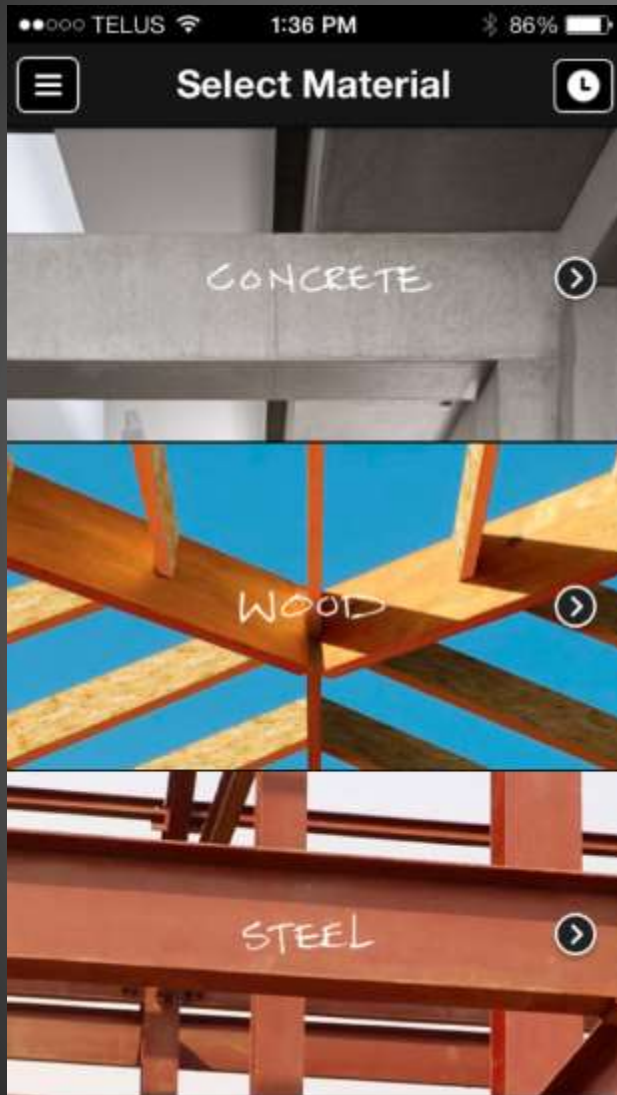

CONCEPT App | Depth Calculator Results

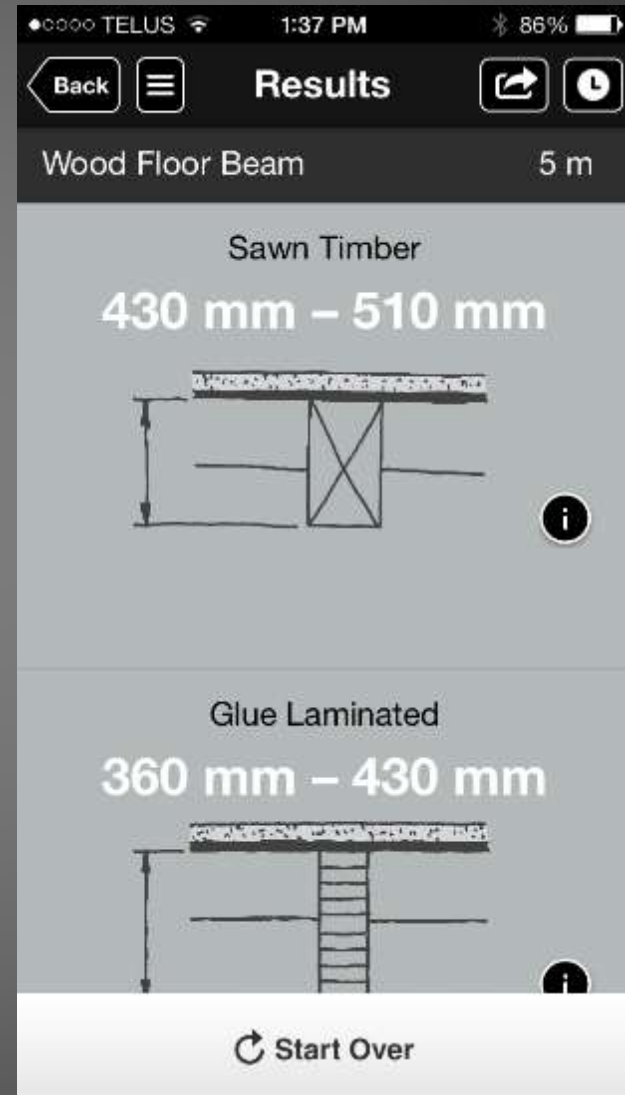
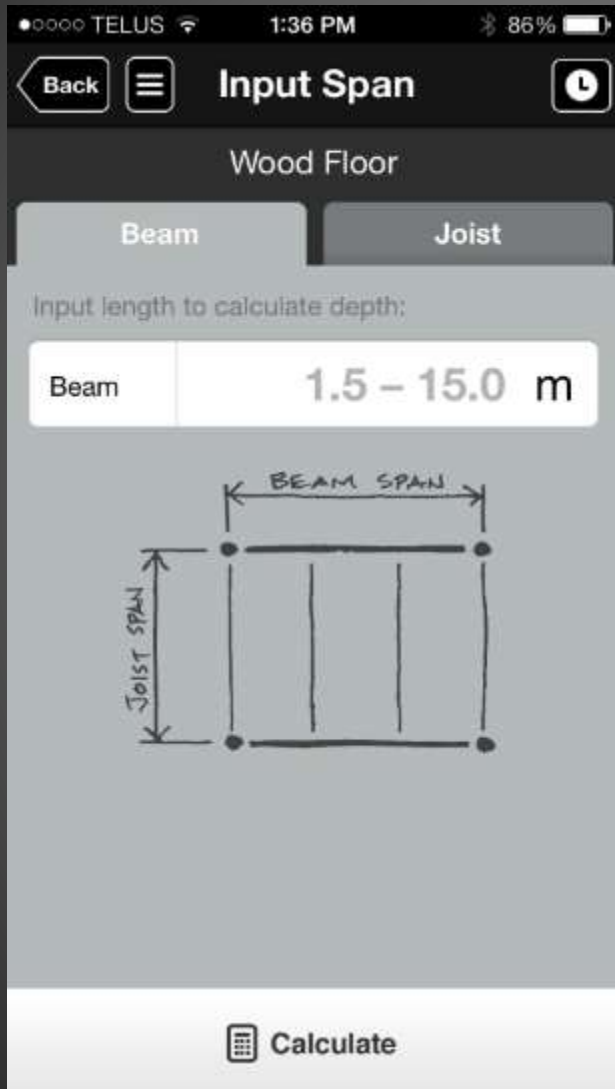

CONCEPT App | Material Gallery

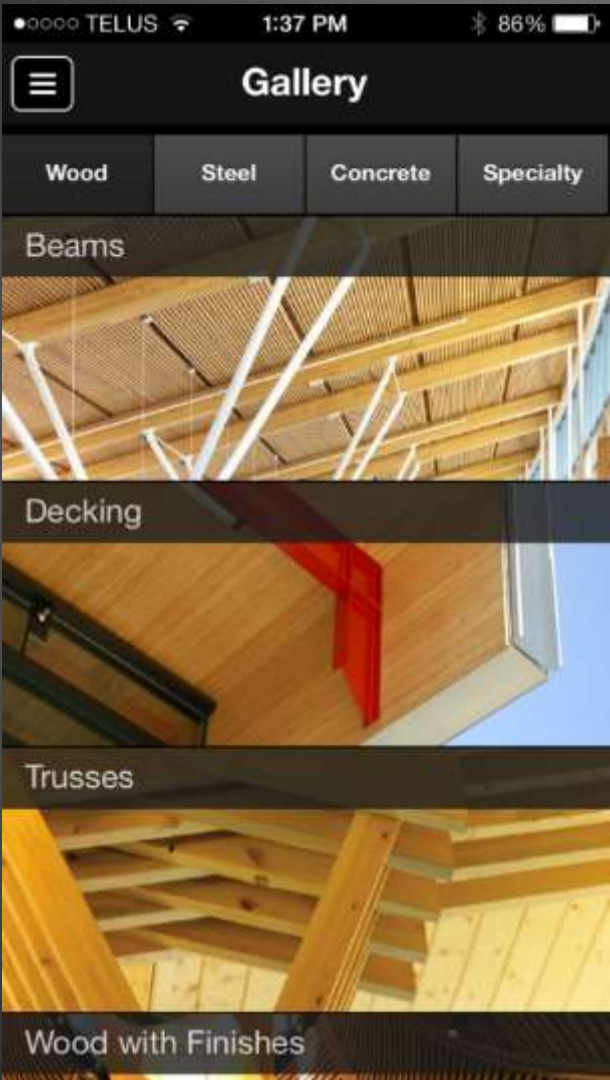

CONCEPT App | Material Gallery

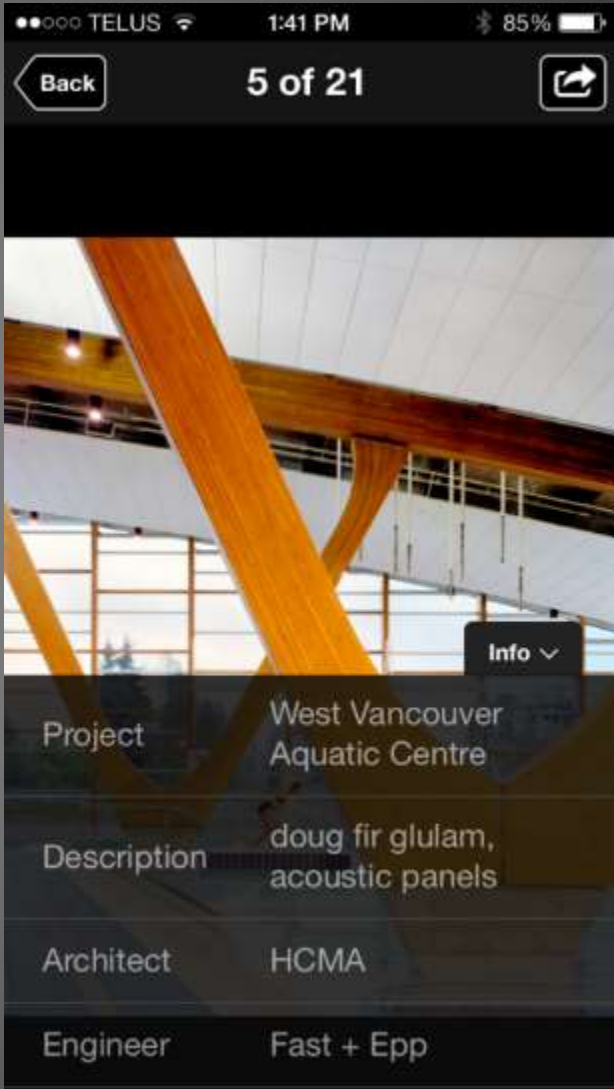

CONCEPT App |

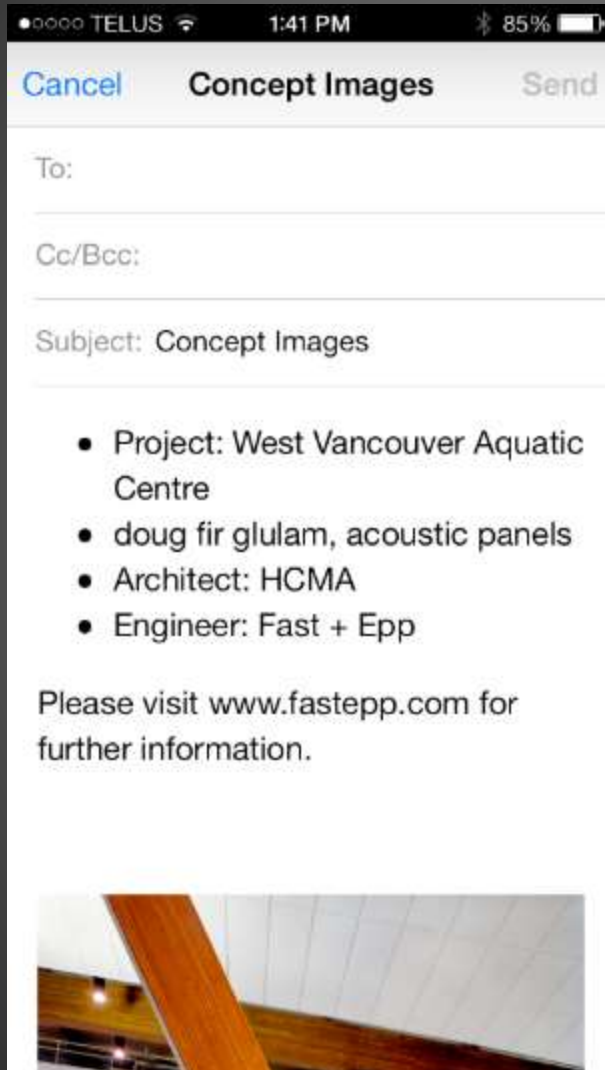

Available on iTunes or visit
www.fastepp.com for more
information

Thank You

